

MONITOUCH

Training Manual Practical Guide



Record of Revisions

Reference numbers are shown at the bottom left corner on the back cover of each manual.

Printing Date	Reference No.	Revised Contents
July, 2014	1070NE0	First edition

Preface

Thank you for selecting the MONITOUCH V9 series.

For correct setup of the V9 series, you are requested to read through this manual to understand more about the product.

For details on other operating procedures for the V9 series, refer to the following related manuals.

Manual Name	Contents	Reference No.
V9 Series Training Manual Beginner's Guide	Explains the screen creation process for the V9 series using V-SFT version 6 with examples.	1069NE
V9 Series Training Manual Practical Guide		1070NE
V9 Series Reference Manual [1]	Explains the functions and operation of the V9 series.	1065NE
V9 Series Reference Manual [2]		1066NE
V9 Series Troubleshooting/Maintenance Manual	Provides an error list and explains the operating procedures for the V9 series.	1068NE
V9 Series Macro Reference	Provides an overview of macros of V-SFT version 6 and explains macro editor operations and macro command descriptions in detail.	1071NE
V9 Series Connection Manual [1]	Explains the connection and communication parameters for the V9 series and controllers in detail. Included Makers ALLEN BRADLEY, Automationdirect, Azbil, Baumuller, BECKHOFF, CHINO, CIMON, DELTA, DELTA TAU DATA SYSTEMS, EATON Cutler-Hammer, EMERSON, FANUC, FATEK AUTOMATION, FUFENG, Fuji Electric, Gammaflux, GE Fanuc, Hitachi, Hitachi Industrial Equipment Systems	2210NE
V9 Series Connection Manual [2]	Explains the connection and communication parameters for the V9 series and controllers in detail. Included Makers IAI, IDEC, JTEKT, KEYENCE, KOGANEI, KOYO ELECTRONICS, LS, MITSUBISHI ELECTRIC, MODICON, MOELLER, M-SYSTEM, OMRON, Oriental Motor, Panasonic, RKC, RS Automation	2211NE
V9 Series Connection Manual [3]	Explains the connection and communication parameters for the V9 series and controllers in detail. Included Makers SAIA, SAMSUNG, SanRex, SANMEI, SHARP, SHIMADEN, SHINKO TECHNOS, Siemens, SINFONIA TECHNOLOGY, TECO, Telemecanique, TOHO, TOSHIBA, TOSHIBA MACHINE, TURCK, UNIPULSE, UNITRONICS, VIGOR, WAGO, XINJE, YAMAHA, Yaskawa Electric, Yokogawa Electric, MODBUS, Barcode Reader, Slave Communication Function, Universal Serial Communication	2212NE
V9 Series Hardware Specifications	Explains hardware specifications and precautions when handling the V9 series.	2023NE

For details on devices including PLCs, inverters, and temperature controllers, refer to the manual for each device.

Notes:

1. This manual may not, in whole or in part, be printed or reproduced without the prior written consent of Hakko Electronics Co., Ltd.
2. The information in this manual is subject to change without prior notice.
3. Windows and Excel are registered trademarks of Microsoft Corporation in the United States and other countries.
4. All other company names or product names are trademarks or registered trademarks of their respective holders.
5. This manual is intended to give accurate information about MONITOUCH hardware. If you have any questions, please contact your local distributor.

Notes on Safe Usage of MONITOUCH

In this manual, you will find various notes categorized under the following levels with the signal words "DANGER" and "CAUTION".

 **DANGER** Indicates an imminently hazardous situation which, if not avoided, will result in death or serious injury.

 **CAUTION** Indicates a potentially hazardous situation which, if not avoided, may result in minor or moderate injury and could cause property damage.

Note that there is a possibility that items listed with  **CAUTION** may have serious ramifications.

DANGER

- Never use the output signal of the V9 series for operations that may threaten human life or damage the system, such as signals used in case of emergency. Please design the system so that it can cope with a touch switch malfunction. A touch switch malfunction may result in machine accidents or damage.
- Turn off the power supply when you set up the unit, connect new cables, or perform maintenance or inspections. Otherwise, electrical shock or damage may occur.
- Never touch any terminals while the power is on. Otherwise, electrical shock may occur.
- You must cover the terminals on the unit before turning the power on and operating the unit. Otherwise, electrical shock may occur.
- The liquid crystal in the LCD panel is a hazardous substance. If the LCD panel is damaged, do not ingest the leaked liquid crystal. If leaked liquid crystal makes contact with skin or clothing, wash it away with soap and water.
- Never disassemble, recharge, deform by pressure, short-circuit, reverse the polarity of the lithium battery, nor dispose of the lithium battery in fire. Failure to follow these conditions will lead to explosion or ignition.
- Never use a lithium battery that is deformed, leaking, or shows any other signs of abnormality. Failure to follow these conditions will lead to explosion or ignition.
- The power lamp flashes when the backlight has reached the end of its service life or when the backlight is faulty. Note that the switches on the screen remain operable when this occurs. Do not touch the screen when the screen becomes dark and the power lamp is flashing. Otherwise, a malfunction may occur and result in machine accidents or damage.

CAUTION

- Check the appearance of the unit when it is unpacked. Do not use the unit if any damage or deformation is found. Failure to do so may lead to fire, damage, or malfunction.
- For use in a facility or as part of a system related to nuclear energy, aerospace, medical, traffic equipment, or mobile installations, please consult your local distributor.
- Operate (or store) the V9 series under the conditions indicated in this manual and related manuals. Failure to do so could cause fire, malfunction, physical damage, or deterioration.
- Observe the following environmental restrictions on use and storage of the unit. Otherwise, fire or damage to the unit may result.
 - Avoid locations where there is a possibility that water, corrosive gas, flammable gas, solvents, grinding fluids, or cutting oil can come into contact with the unit.
 - Avoid high temperatures, high humidity, and outside weather conditions, such as wind, rain, or direct sunlight.
 - Avoid locations where excessive dust, salt, and metallic particles are present.
- Avoid installing the unit in a location where vibrations or physical shocks may be transmitted.
- Equipment must be correctly mounted so that the main terminal of the V9 series will not be touched inadvertently. Otherwise, an accident or electric shock may occur.
- Tighten the mounting screw on the fixtures of the V9 series to an equal torque of 0.6 N·m.
- Excessive tightening may distort the panel surface. Loose mounting screws may cause the unit to fall down, malfunction, or short-circuit.
- Check periodically that terminal screws on the power supply terminal block and fixtures are firmly tightened. Loosened screws or nuts may result in fire or malfunction.
- Tighten the terminal screws on the power supply terminal block of the V9 series to an equal torque of 7.1 to 8.8 inch-lbf (0.8 to 1.0 N·m). Improper tightening of screws may result in fire, malfunction, or other serious trouble.
- The V9 series has a glass screen. Do not drop the unit or impart physical shocks to the unit. Otherwise, the screen may be damaged.
- Correctly connect cables to the terminals of the V9 series in accordance with the specified voltage and wattage. Overvoltage, overwattage, or incorrect cable connection could cause fire, malfunction, or damage to the unit.
- Always ground the V9 series. The FG terminal must be used exclusively for the V9 series with the level of grounding resistance less than 100 Ω. Otherwise, electric shock or a fire may occur.
- Prevent any conductive particles from entering the V9 series. Failure to do so may lead to fire, damage, or malfunction.
- After wiring is finished, remove the paper used as a dust cover before starting operation of the V9 series. Operation with the dust cover attached may result in accidents, fire, malfunction, or other trouble.

 **CAUTION**

- Do not attempt to repair the V9 series yourself. Contact Hako Electronics or the designated contractor for repairs.
- Do not repair, disassemble, or modify the V9 series. Hako Electronics Co., Ltd. is not responsible for any damages resulting from repair, disassembly, or modification of the unit that was performed by an unauthorized person.
- Do not use sharp-pointed tools to press touch switches. Doing so may damage the display unit.
- Only experts are authorized to set up the unit, connect cables, and perform maintenance and inspection.
- Lithium batteries contain combustible material such as lithium and organic solvents. Mishandling may cause heat, explosion, or ignition resulting in fire or injury. Read the related manuals carefully and correctly handle the lithium battery as instructed.
- Do not press two or more positions on the screen at the same time. If two or more positions are pressed at the same time, the switch located between the pressed positions may be activated.
- Take safety precautions during operations such as changing settings when the unit is running, forced output, and starting and stopping the unit. Any misoperations may cause unexpected machine movement, resulting in machine accidents or damage.
- In facilities where the failure of the V9 series could lead to accidents that threaten human life or other serious damage, be sure that such facilities are equipped with adequate safeguards.
- When disposing of the V9 series, it must be treated as industrial waste.
- Before touching the V9 series, discharge static electricity from your body by touching grounded metal. Excessive static electricity may cause malfunction or trouble.
- Insert an SD card into the unit in the same orientation as pictured on the unit. Failure to do so may damage the SD card or the slot on the unit.
- The SD card access LED flashes red when the SD card is being accessed. Never remove the SD card or turn off power to the unit while the LED is flashing. Doing so may destroy the data on the SD card. Check that the LED has turned off before removing the SD card or turning off the power to the unit.

[General Notes]

- Never bundle control cables or input/output cables with high-voltage and large-current carrying cables such as power supply cables. Keep control cables and input/output cables at least 200 mm away from high-voltage and large-current carrying cables. Otherwise, malfunction may occur due to noise.
- When using the V9 series in an environment where a source of high-frequency noise is present, it is recommended that the FG shielded cable (communication cable) be grounded at each end. However, when communication is unstable, select between grounding one or both ends, as permitted by the usage environment.
- Be sure to plug connectors and sockets of the V9 series in the correct orientation. Failure to do so may lead to damage or malfunction.
- If a LAN cable is inserted into the MJ1 or MJ2 connector, the device on the other end may be damaged. Check the connector names on the unit and insert cables into the correct connectors.
- Do not use thinners for cleaning because it may discolor the V9 series surface. Use commercially available alcohol.
- If a data receive error occurs when the V9 series unit and a counterpart unit (PLC, temperature controller, etc.) are started at the same time, read the manual of the counterpart unit to correctly resolve the error.
- Avoid discharging static electricity on the mounting panel of the V9 series. Static charge can damage the unit and cause malfunctions. Discharging static electricity on the mounting panel may cause malfunction to occur due to noise.
- Avoid prolonged display of any fixed pattern. Due to the characteristic of liquid crystal displays, an afterimage may occur. If prolonged display of a fixed pattern is expected, use the backlight's auto OFF function.
- The V9 series is identified as a class-A product in industrial environments. In the case of use in a domestic environment, the unit is likely to cause electromagnetic interference. Preventive measures should thereby be taken appropriately.

[Notes on the LCD]

Note that the following conditions may occur under normal circumstances.

- The response time, brightness, and colors of the V9 series may be affected by the ambient temperature.
- Tiny spots (dark or luminescent) may appear on the display due to the characteristics of liquid crystal.
- There are variations in brightness and color between units.

Contents

1	Practical Guide Configuration	
1.1	Edit Model	1-1
1.2	Connection Configuration.....	1-1
1.3	Screen Configuration	1-1
2	Preparation	
2.1	Creating a New Screen Program	2-1
2.2	Creating a Menu Screen.....	2-4
2.2.1	Screen Editing	2-5
3	Trend Parts	
3.1	Overview	3-1
3.2	Screen Example	3-2
3.3	Screen Creation	3-3
3.3.1	Logging Server Settings	3-3
3.3.2	Screen Editing	3-7
3.4	Checking Unit Operation	3-21
3.4.1	List of Used Device Memory Addresses	3-21
3.4.2	Unit Operation	3-21
4	Recipe	
4.1	Overview	4-1
4.2	Screen Example	4-2
4.3	Screen Creation	4-3
4.3.1	Recipe Settings	4-3
4.3.2	Screen Editing	4-9
4.4	Checking Unit Operation	4-13
4.4.1	List of Used Device Memory Addresses	4-13
4.4.2	Unit Operation	4-13
5	Scheduler	
5.1	Overview	5-1
5.2	Screen Example	5-2
5.3	Screen Creation	5-3
5.3.1	Scheduler Settings	5-3
5.3.2	Screen Editing	5-5
5.4	Checking Unit Operation	5-11
5.4.1	List of Used Device Memory Addresses	5-11
5.4.2	Unit Operation	5-11

6 Security

6.1	Overview	6-1
6.2	Screen Example	6-2
6.3	Screen Creation	6-4
6.3.1	Security Settings	6-4
6.3.2	Screen Editing (Screen Example 1)	6-5
6.3.3	Screen Editing (Screen Example 2)	6-12
6.4	Checking Unit Operation	6-14
6.4.1	List of Used Device Memory Addresses	6-14
6.4.2	Unit Operation	6-14

7 Operation Logs

7.1	Overview	7-1
7.2	Screen Example	7-2
7.3	Screen Creation	7-3
7.3.1	Operation Log Settings	7-3
7.3.2	Screen Editing	7-4
7.4	Checking Unit Operation	7-10
7.4.1	List of Used Device Memory Addresses	7-10
7.4.2	Unit Operation	7-10

8 Changing Languages

8.1	Overview	8-1
8.2	Screen Example	8-2
8.3	Screen Creation	8-3
8.3.1	Font Settings	8-3
8.3.2	Screen Editing	8-4
8.3.3	Redraw Timing	8-11
8.4	Checking Unit Operation	8-12

9 Device Memory Map

9.1	Overview	9-1
9.2	Screen Example	9-2
9.3	Connecting to the Fuji Electric PXR	9-3
9.3.1	V-SFT Settings	9-3
9.3.2	PXR Settings	9-3
9.4	Screen Creation	9-4
9.4.1	Editing Device Memory Maps	9-4
9.4.2	Screen Editing	9-6
9.5	Checking Unit Operation	9-10
9.5.1	List of Used Device Memory Addresses	9-10
9.5.2	PXR (PLC2) Communication State Confirmation	9-10
9.5.3	Unit Operation	9-11

10 Convenient Functions

10.1	Zoom in	10-1
10.1.1	Overview	10-1
10.1.2	Screen Example	10-1
10.1.3	Enlarged Display Settings	10-2
10.1.4	Checking Unit Operation	10-2
10.2	Enlarging the Screen Size	10-3
10.2.1	Overview	10-3
10.2.2	Screen Example	10-3
10.2.3	Screen Creation	10-4
10.2.4	Checking Unit Operation	10-5
10.3	VNC Server	10-6
10.3.1	Overview	10-6
10.3.2	Operation Example	10-7
10.3.3	V9 Local Screen Settings	10-7
10.3.4	Checking Unit Operation	10-11

1 Practical Guide Configuration

Screens are created using the following configuration in this manual.

1.1 Edit Model

V9100iS (800 × 600 pixels)

1.2 Connection Configuration

PLC1: MITSUBISHI ELECTRIC QnU series CPU, Connection port: CN1

PLC2: Fuji Electric PXR (MODBUS RTU), Connection port: MJ2

PLC3 to 8: Not used.

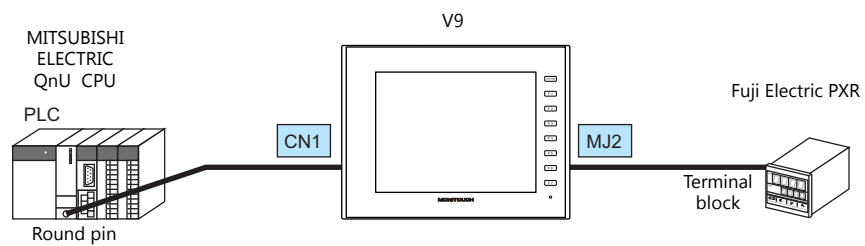

1.3 Screen Configuration

Screen

- Screen 0 (page 2-1)

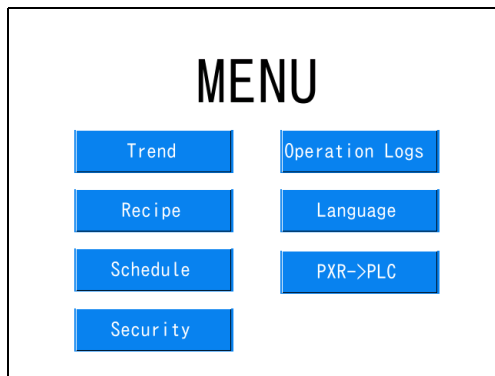

- Screen 1 (page 3-1)

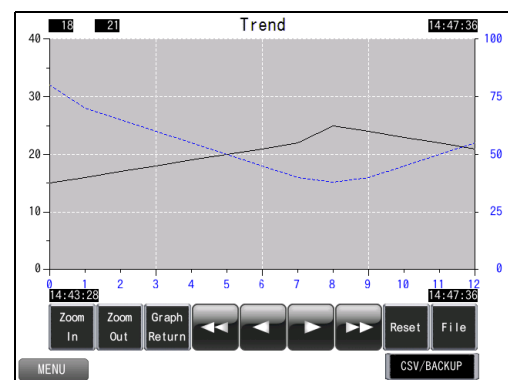

- Screen 2 (page 4-1)

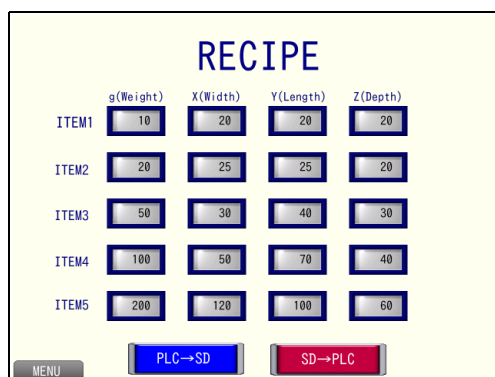

- Screen 3 (page 5-1)

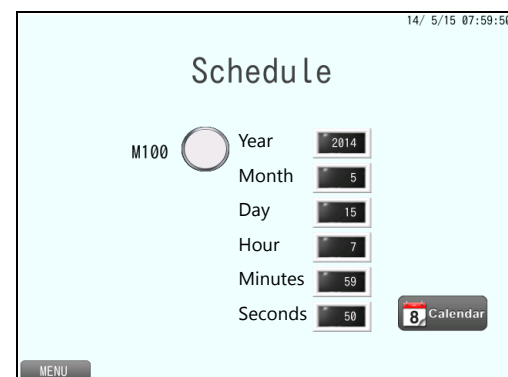

- Screen 4 (page 6-1)

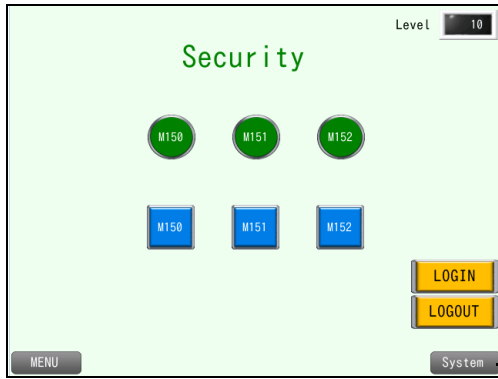

Screen 10

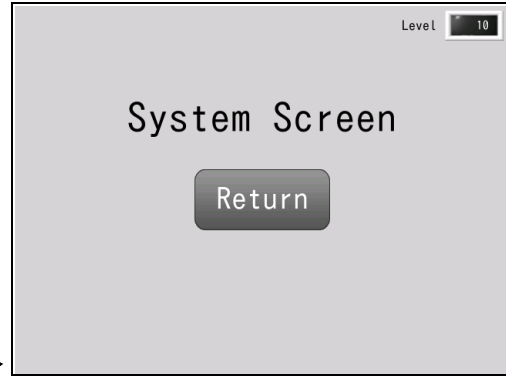

- Screen 5 (page 7-1)



- Screen 6 (page 8-1)



- Screen 7 (page 9-1)

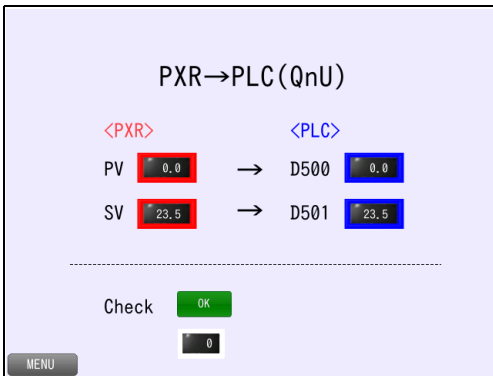

- Screen 0 (page 10-1)

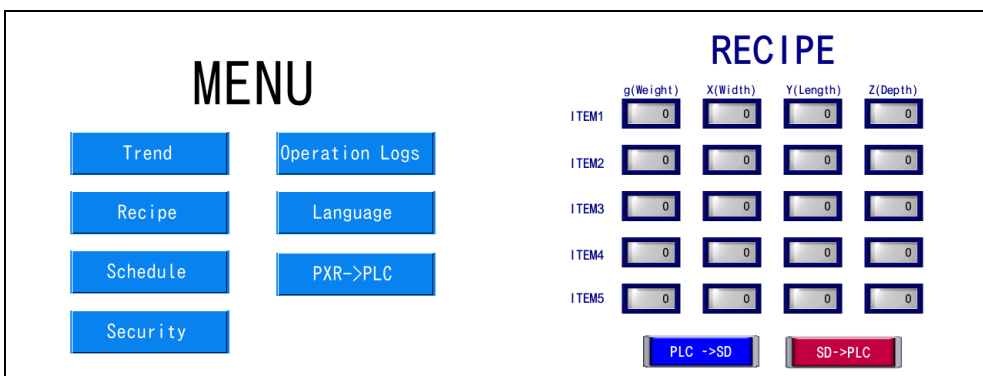

Creation of a menu screen (screen 0) with an added recipe screen (screen 2).

2 Preparation

2.1 Creating a New Screen Program

Create a new screen program.

1. Start V-SFT version 6.
2. Click [New].

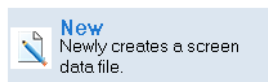

OR

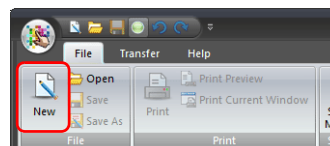

3. The [Edit Model Selection] window is displayed. In this manual, configure the following settings and click [OK].

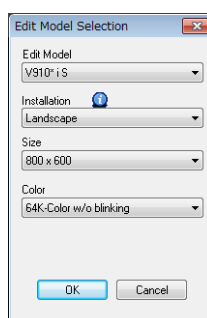

Item	Description	Setting Value
Edit Model	Select a model.	V910* iS
Installation	Select the installation direction of the MONITOUCH.	Landscape
Size	Display resolutions for the selected model are displayed.	800 × 600
Color	Select the number of display colors.	64K-Color w/o blinking

4. The [PLC1 Connection Device Selection] window is displayed. Select the following PLC model and connection port and click [OK].

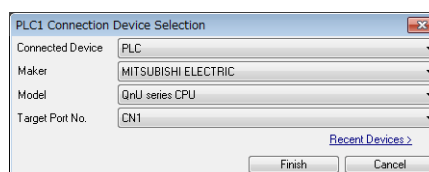

Item (PLC1)	Description	Setting Value
Connected Device	Select the connected device (PLC, temperature controller etc.).	PLC
Maker	Select the manufacturer and model of the connected device.	MITSUBISHI ELECTRIC QnU series CPU
Model		
Target Port No.	Select the connection port on the V9 series unit.	CN1

- The [Hardware Setting] and [PLC1 Properties] windows are displayed.
Configure the communication settings in the PLC properties window and then close the PLC properties.
(In this manual, communication settings are not required because the PLC model is set to "QnU series CPU".)

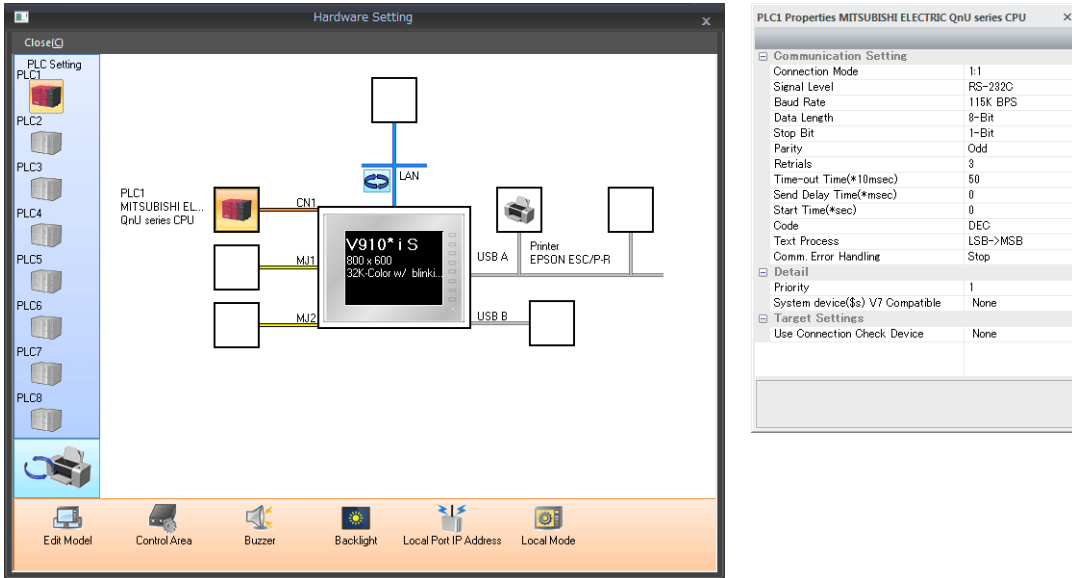

Refer to the V9 Series Connection Manual.

- Click [Control Area] and configure the following settings.

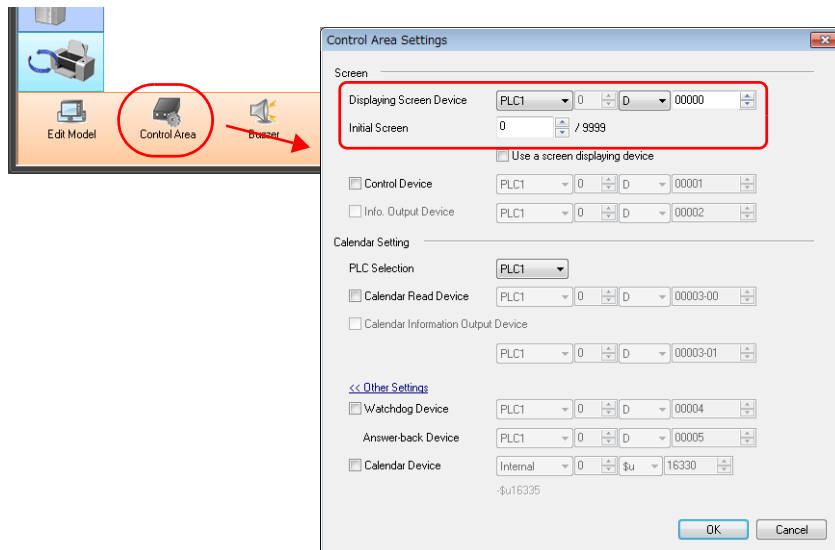

Item	Description	Setting Value
Displaying Screen Device	The device memory used when switching screens using an external command. When the screen number to show is specified, the display switches to the corresponding screen. If a screen was switched using an internal switch, the current display screen number is stored in this device memory.	D00000
Initial Screen	Set the screen number to display at startup. If the [Use a screen displaying device] checkbox is selected, the screen number set for [Displaying Screen Device] is displayed as the initial screen.	0
Control Device	For more information, refer to the V9 Series Reference Manual.	Unselected
Info. Output Device		PLC1
PLC Selection		Unselected
Calendar Read Device		
Calendar Information Output Device		
Watchdog Device		
Answer-back Device		
Calendar Device		

7. Click the close button to close the [Hardware Setting] window.



8. Click [System Setting] → [Multi-language Setting] to display the [Font Setting] window.

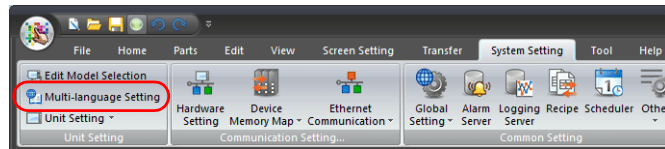

9. Set a font and click [OK].

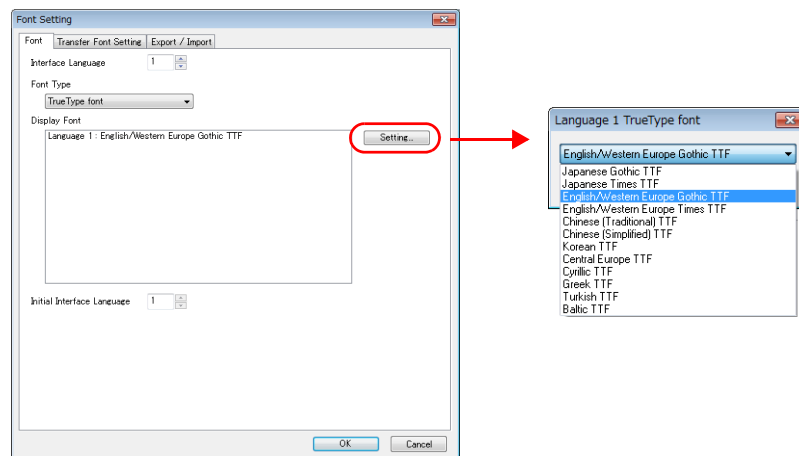

This completes the settings required to create a new screen program.

2.2 Creating a Menu Screen

Create a menu screen on screen 0.
Create switches for changing between screens.

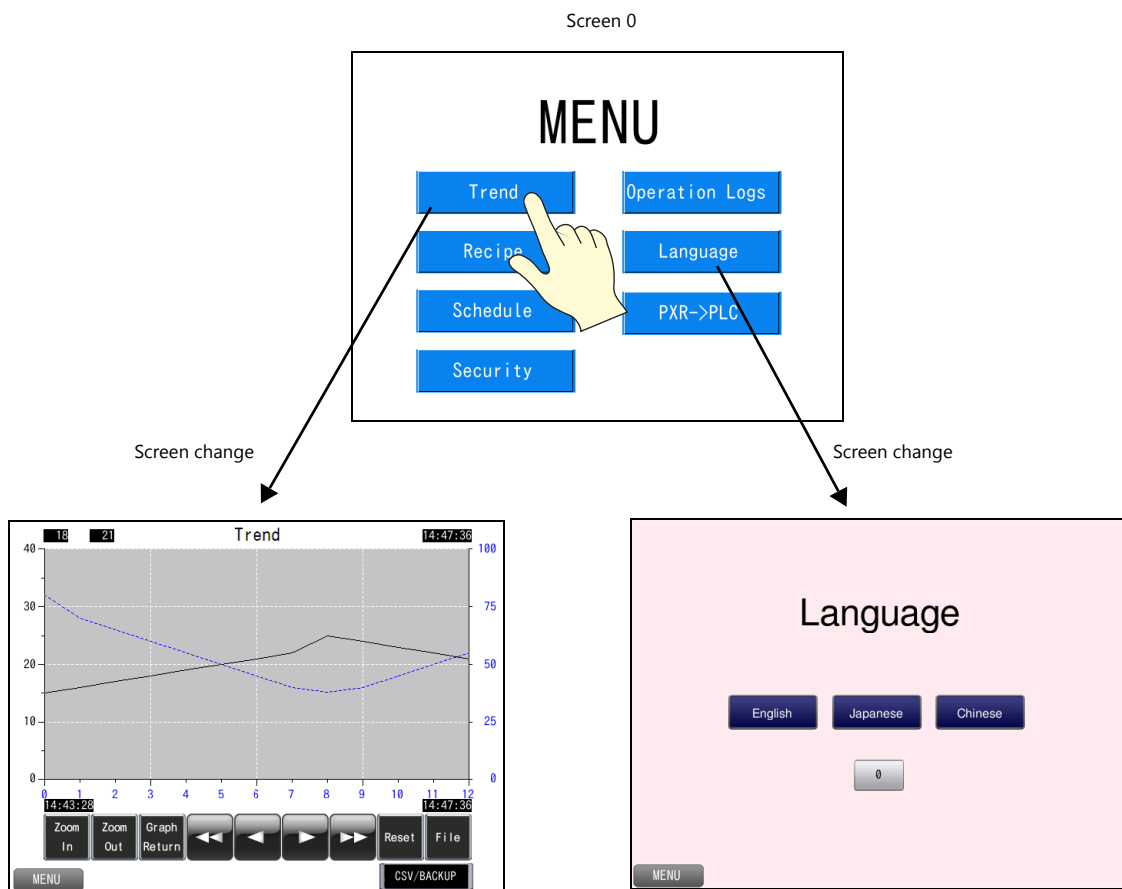

2.2.1 Screen Editing

Display screen 0.

Placing Text

Create a screen title.

1. Click [Home] → [Text] → [Text] and click on the screen.
2. Enter text.

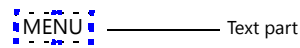

3. Click a location on the screen other than the text.
4. Click the text to display its item view window. Change the text color and text size properties.

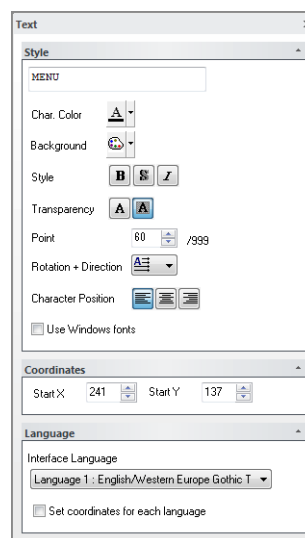

This completes the text creation process.



Placing a Switch (for Changing Screens)

1. Click [Home] → [Switch] and place a switch on the screen.
2. Double-click the switch to display the settings window and configure the following settings.
 - Style
Select the design and color.
 - Char. Prop.
Set the text and color etc.

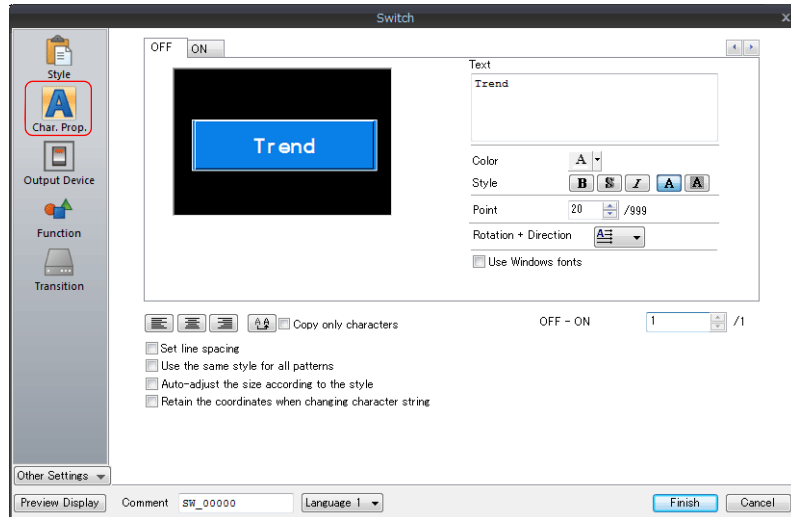

Item	Description	Setting Value
Text	Set the text to be displayed on the switch.	Trend

- Function

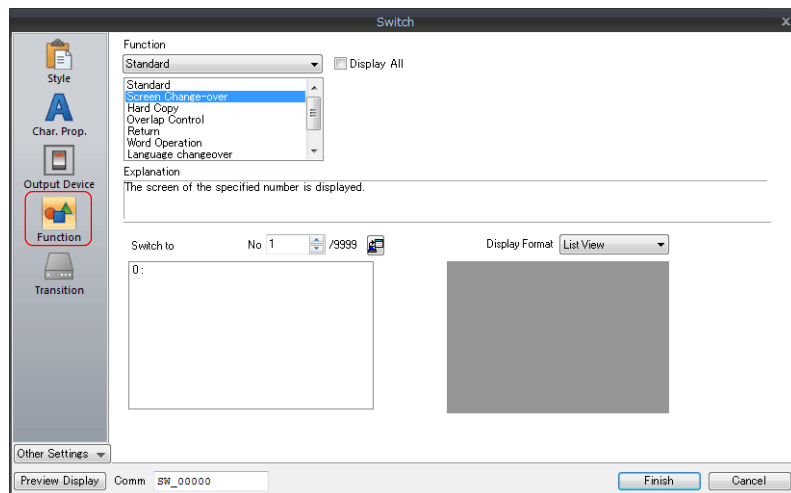

Item	Description	Setting Value
Function	Set the function to use.	Standard: Screen Change-over Switch to: No. 1

3. Click [Finish] to close the window.

Creating Multiple Copies of Switches

Make multiple copies of a switch.

1. Select the placed switch and click [Edit] → [Multi-copy].
2. Configure the following settings and click [OK].

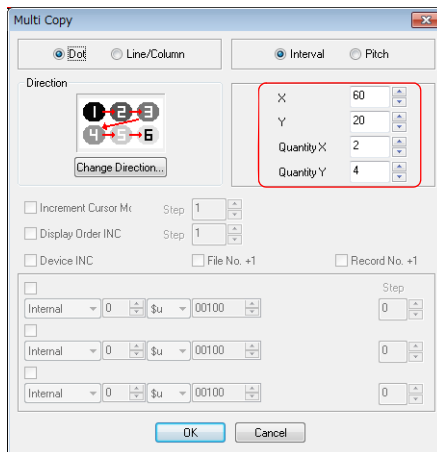

[Quantity X]: 2
[Quantity Y]: 4

3. This makes eight copies of the switch. The switch on the lower right is not needed so delete it. Configure the following settings for each switch.

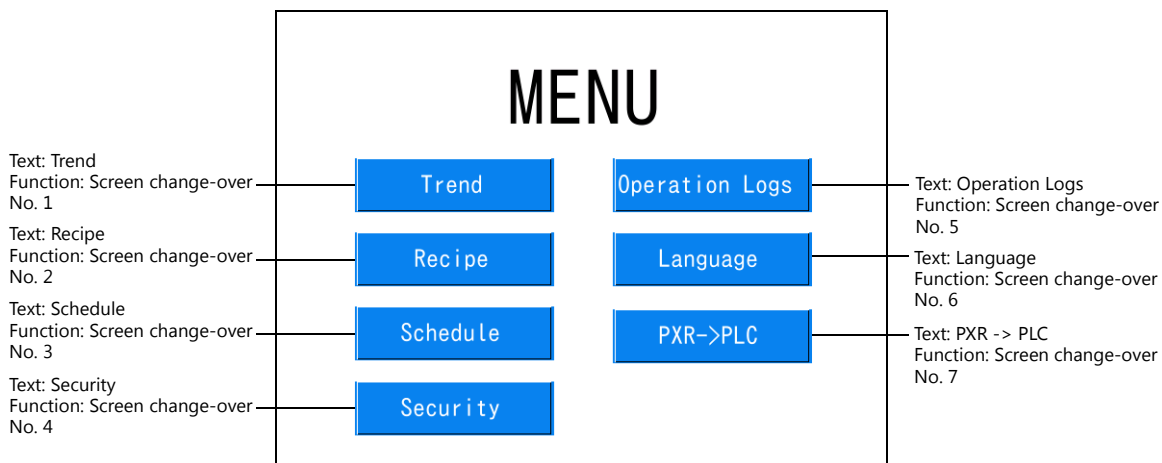

This completes creation of the menu screen (screen 0).

MEMO

MONITOUCH



3 Trend Parts

3.1 Overview

PLC device memory values can be read regularly and changes in their values can be displayed on line graphs or as numerical data (text).

Data is read according to a fixed cycle or a 0 → 1 change in the bit status of a trigger bit.

History data accumulates in an area referred to as a logging server.

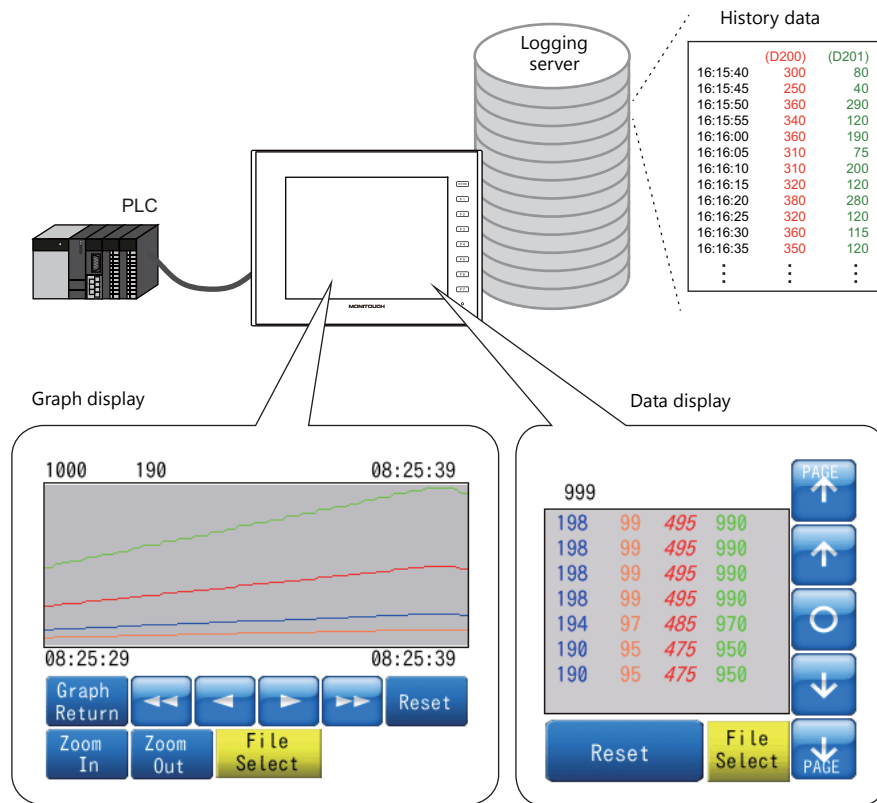

A single area can display a maximum of 16 graph lines or data.

Configure the following two items.

- Logging server: For accumulating changing data.
- Trend part: For displaying accumulated data.



Logging server

This area is for saving logged data. A maximum of 12 data entries can be registered.

Logging data is saved to the internal storage setting (DRAM/SRAM) first, and can then be output to a storage device.

3.2 Screen Example

This chapter explains how to create a graph display screen that captures history data from D300 and D301 when the M10 trigger bit turns ON (0 → 1).

Screen 1

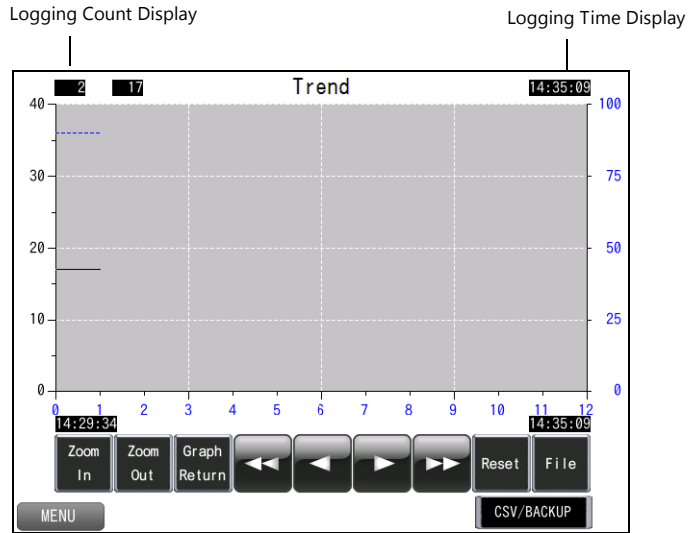

Continue logging when the M10 trigger bit turns ON (0 → 1).

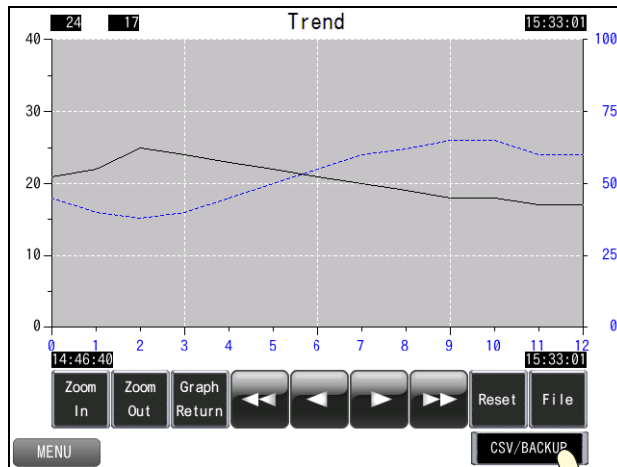

Output a CSV/backup file when the M100 storage output bit turns ON (0 → 1).

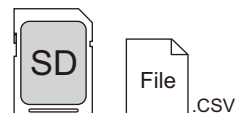

3.3 Screen Creation

3.3.1 Logging Server Settings

1. Click [System Setting] → [Logging Server] to display the logging server window.

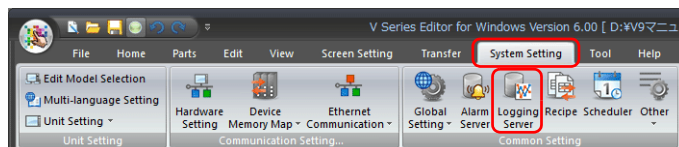

2. Click [Add], set [Additional No.] to "0", and click [Complete].
3. Select [No. 0] and set [Logging] to [Trigger].

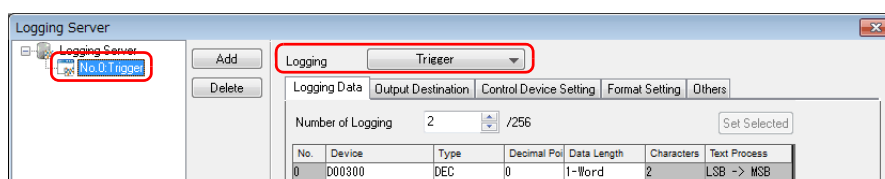

4. Configure the following settings.

- Logging Data

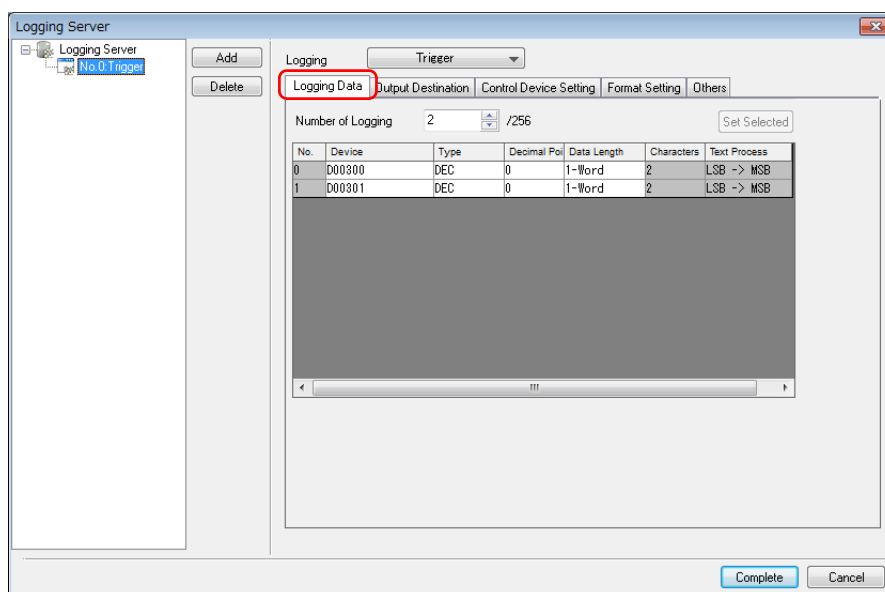

Item	Description	Setting Value
Number of Logging	Set the total number of points to log. Max. 256 points.	2
Device	Set the device memory for logging.	No. 0: D300 No. 1: D301
Type Decimal Point Data Length	Set the data format of the specified device memory.	Type: DEC Decimal Point: 0 Data Length: 1-Word

• Output Destination

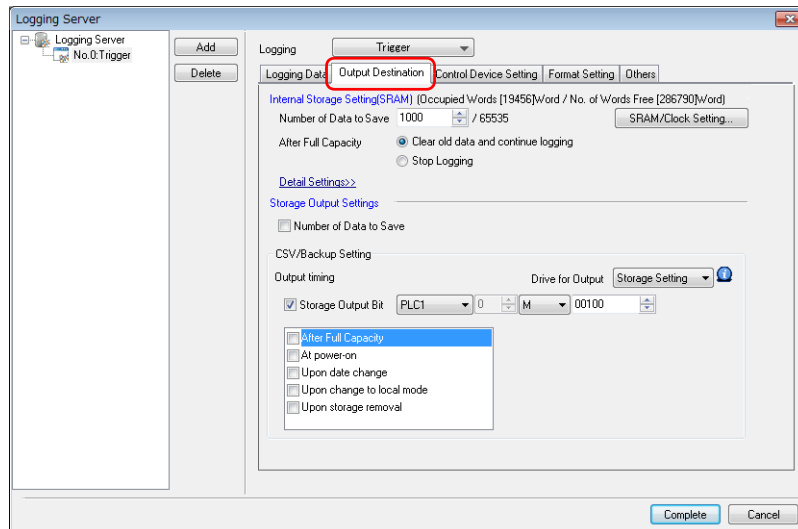

- Internal Storage Setting (SRAM)

Item	Description	Setting Value
Number of Data to Save	Set the number of data entries to save in logging.	1000
After Full Capacity	Set the operation to perform when [Number of Data to Save] is exceeded.	Clear old data and continue logging
Device (Click [Detail Settings])	<p>Set the save destination for logging.</p> <p>SRAM When power to the unit is turned off, history data is backed up (retained by battery) even when changing between RUN and Local mode. The amount of free space and total used space can be checked via [SRAM/Clock Setting].</p> <p>DRAM All history data is cleared when power to the unit is turned OFF or when changing between RUN and Local mode.</p>	SRAM

- Storage Output Settings

Item	Description	Setting Value
Number of Data to Save	Set the amount of data saved in the internal storage settings to save to a BIN file.	Unselected
Output timing	Output data saved in the internal storage settings to a CSV/backup file on the storage device. Output is performed at the set timing. Storage Output Bit (0 → 1) / After Full Capacity / At power-on / Upon date change / Upon change to local mode / Upon storage removal	Storage Output Bit M100
Drive for Output	Set the output destination. Storage Setting: [System Setting] → [Other] → [Storage Setting] C: Built-in Socket D: USB-A Port The folder configuration on storage devices is as follows. <ul style="list-style-type: none"> • CSV output destination (output drive)\access folder\LOGGING folder • Backup output destination (output drive)\access folder\LOGGING\year/month folder\year/month/day folder 	Storage Setting



* Storage folder configuration

E.g.: Logging server number 0, CSV filename: LOGGING_00_00, output drive: Storage Setting (Built-in Socket)

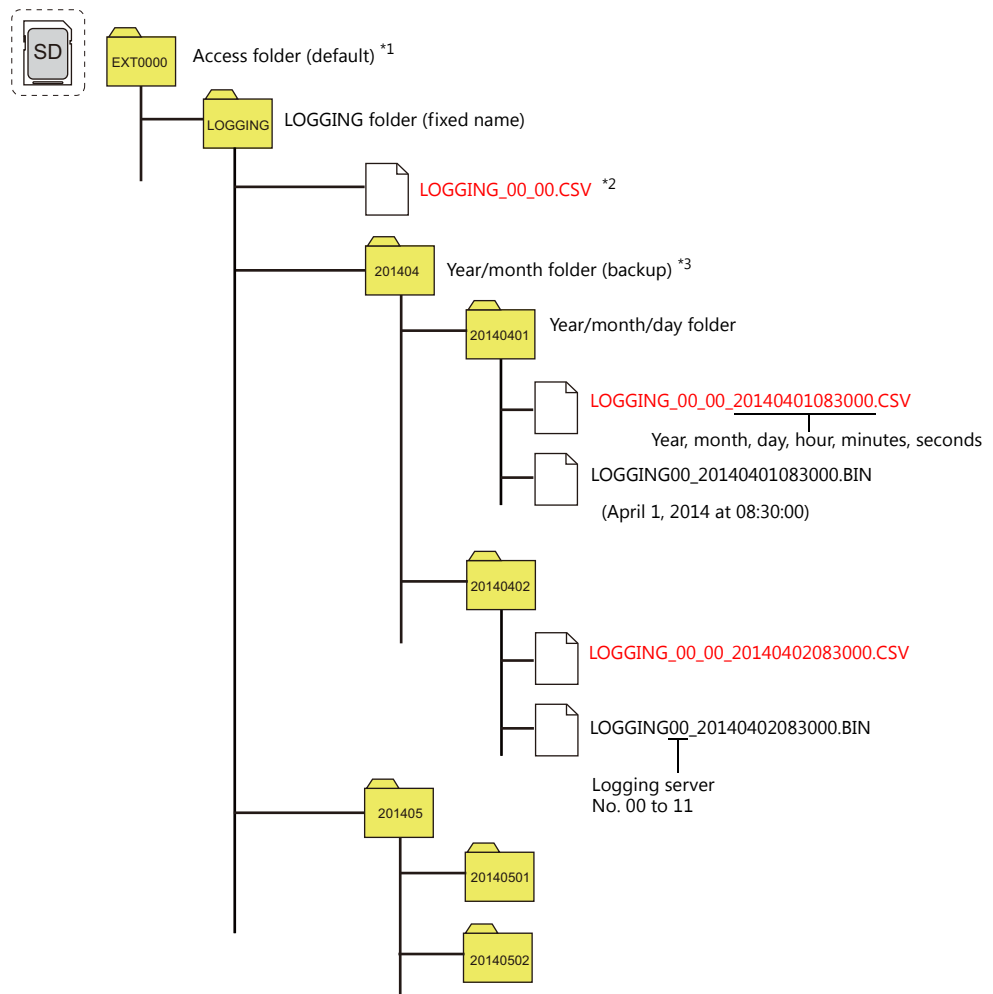

*1 The folder name can be changed at [System Setting] → [Other] → [Storage Setting].

*2 For details on changing the filename, refer to page 3-6.

*3 If a backup is not required, select the [Others] → [Do not output backup files] checkbox.

• Control Device Settings

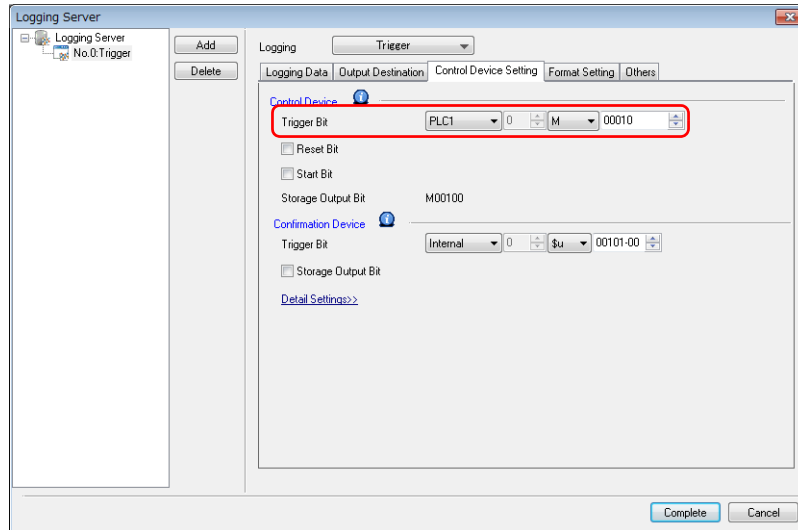

Item	Description	Setting Value
Control Device Trigger Bit	Set the trigger bit to use when [Logging] is set to [Trigger]. Logging is performed when the trigger bit changes from 0 to 1. 0 → 1: Perform logging once.	M10

• Format Settings

Double-click line 0 to display the [Format [0]] window.

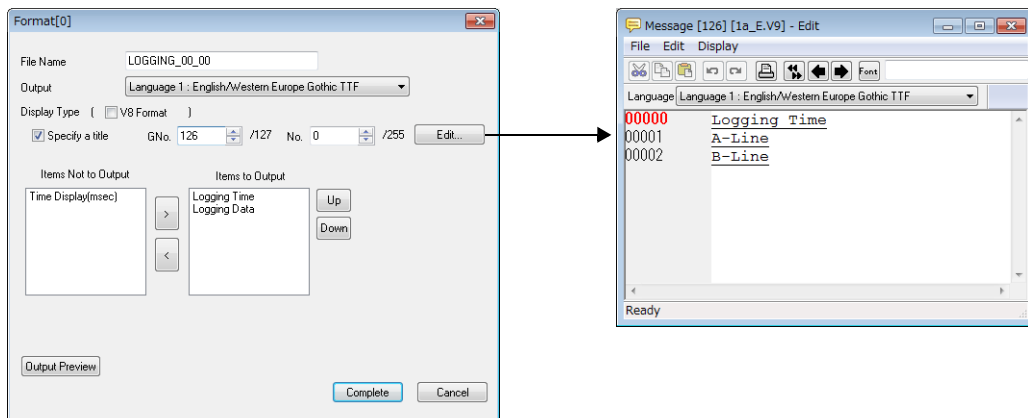

Item	Description	Setting Value
File Name	Set the name of the CSV file. Default: LOGGING_xx_yy.CSV (xx: logging server number, yy: format number) * For more information on file output destinations, refer to page 3-5.	LOGGING_00_00 (default)
Output	Set the language used in the CSV file. No Designation: Output using the displayed language. Language 1 to 16	No Designation
Display Type	Select the checkbox for V8 compatibility.	Unselected
Specify a title	Add titles to the first line (line 1) of the CSV file. Titles are registered in the [Message Edit] window displayed by clicking [Edit].	Selected GNo. 126, No. 0 No. 0: Logging Time No. 1: A-Line No. 2: B-Line
Items to Output	Use the [←] and [→] buttons to set the items to output to the CSV file. Logging Time / Time Display (msec) / Logging Data * Output all logging data. Cells are divided into logging time and time display (msec).	Logging Time Logging Data
Output Preview	Display a preview of the CSV file to be output.	-

Click the [Complete] button.
This completes the necessary settings.

3.3.2 Screen Editing

Placing Trend Parts

Place the parts for displaying history data on a graph.

1. Click [Parts] → [Catalog] to display the catalog view window.

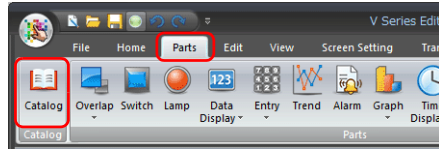

2. Select [Trend] for [Parts], select the desired parts, and drag them onto the screen. This places the parts on the screen.

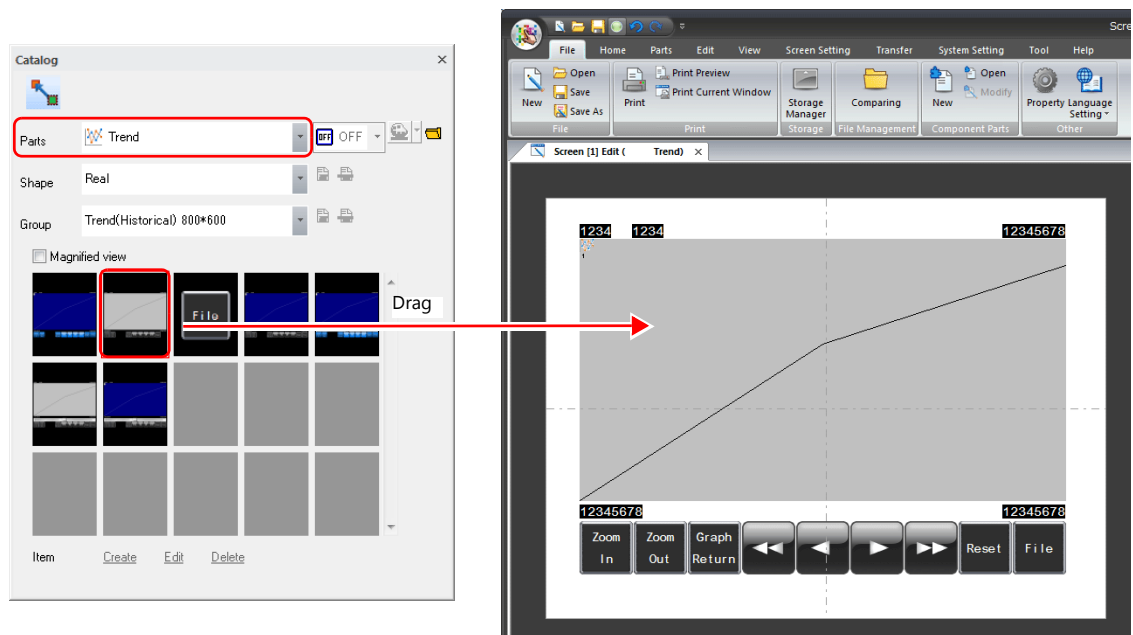

Trend Part Configuration

The parts that comprise trend graphs are as follows.

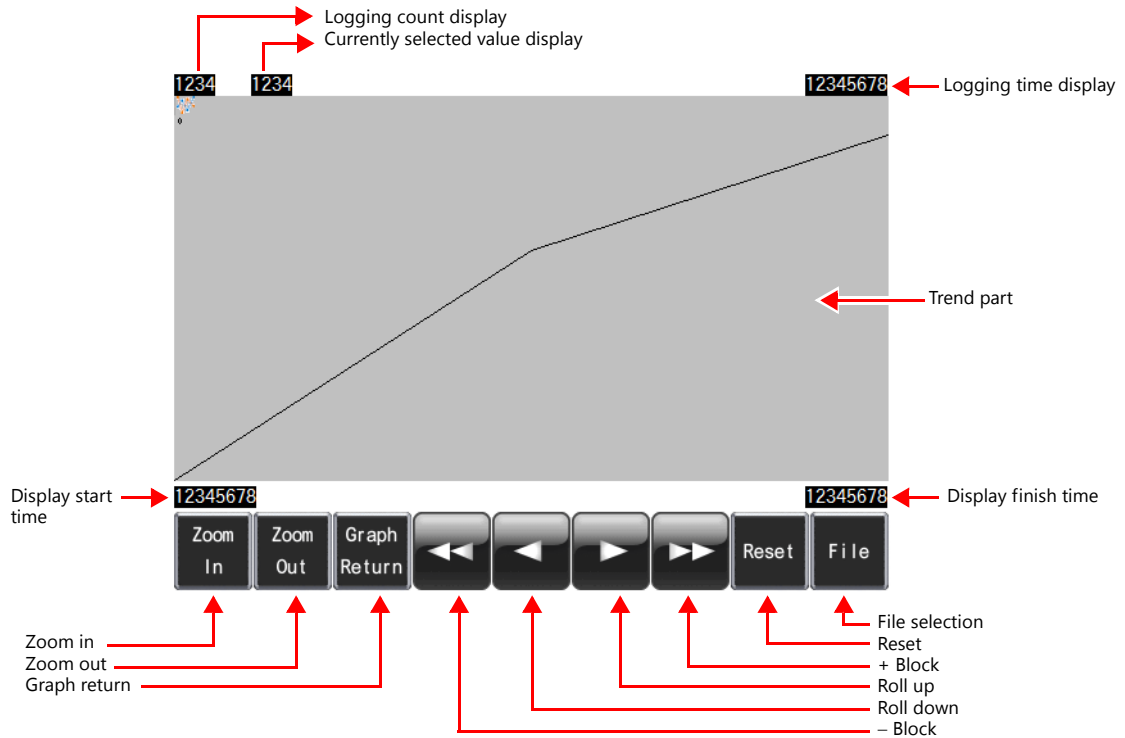

Item	Description
Logging count display	Displays the current number of history data entries or the number of selected history data entries.
Currently selected value display	Displays the latest history data or the selected history data.
Logging time display *1	Displays the latest logging time or the selected logging time.
Display start time *1	Display the logging time of the oldest data on the currently displayed graph.
Display finish time *1	Display the logging time of the newest data on the currently displayed graph.
Zoom in	Enlarge the currently displayed graph in order of actual size → 2 times → 4 times → 8 times.
Zoom out	Reduce the currently displayed graph in order of 8 times → 4 times → 2 times → actual size.
Graph return	Flashes when the cursor is displayed after pressing [+ Block] or [- Block]. Pressing this button when it is flashing will stop it from flashing and return the graph to the latest display state.
- Block	Move the display back one page.
Roll down	Move the cursor to the previous point.
Roll up	Move the cursor to the next point.
+ Block	Move the display forward one page.
Reset	Press once to illuminate the switch and press again within two seconds to clear the switch. Logging resumes after clearing. If the switch is not pressed again within two seconds, the switch is cleared and a reset is not performed.
File	Select a backup file saved to a storage device for display.

*1 Up to the year, month, and day can be displayed if enough digits are specified.

Less than 8 digits	No display
8 to 11 digits	Hour, minutes, and seconds
12 to 17 digits	Hour, minutes, seconds, and milliseconds
18 to 22 digits	Month, day, hour, minutes, seconds, and milliseconds
23 digits or more	Year, month, day, hour, minutes, seconds, and milliseconds

Trend Part Settings

Display the trend settings window and configure settings.

Operation Select

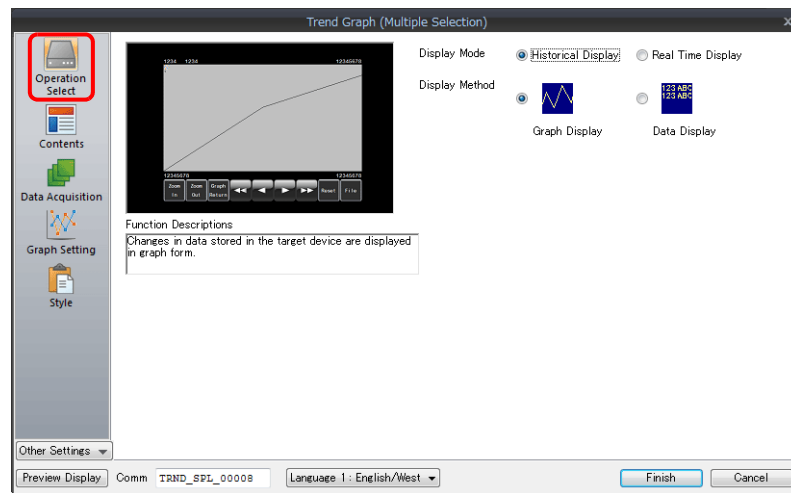

Item	Description	Setting Value
Display Mode	Select [Historical Display].	Historical Display
Display Method	Select [Graph Display].	Graph Display

Contents

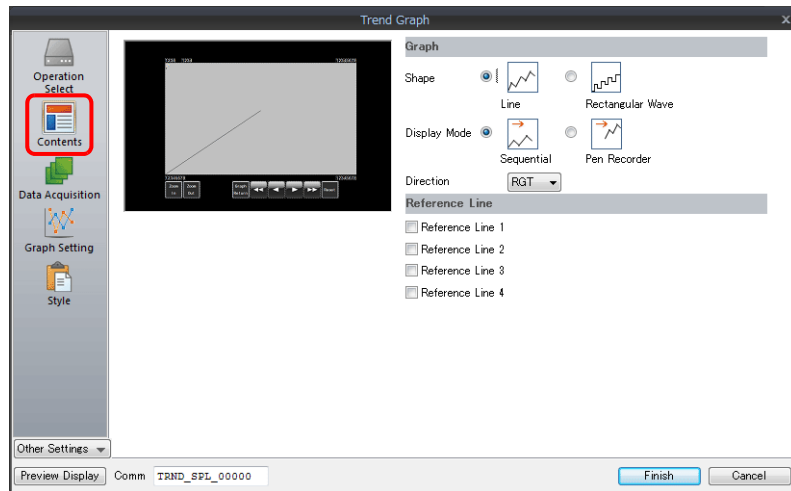

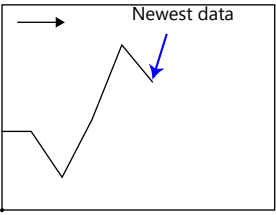
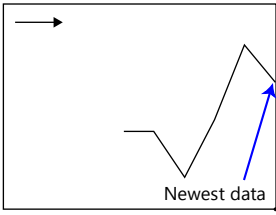
Item	Description	Setting Value
Shape	Specify the graph shape.	Line
Display Mode	<p>[Direction: RGT], [Sequential]</p>  <p>[Direction: RGT], [Pen Recorder]</p> 	Sequential
Direction	Specify the graph direction.	RGT
Reference Line	Display reference lines in the graph area. A maximum of 4 lines can be displayed.	Unselected

Data Acquisition

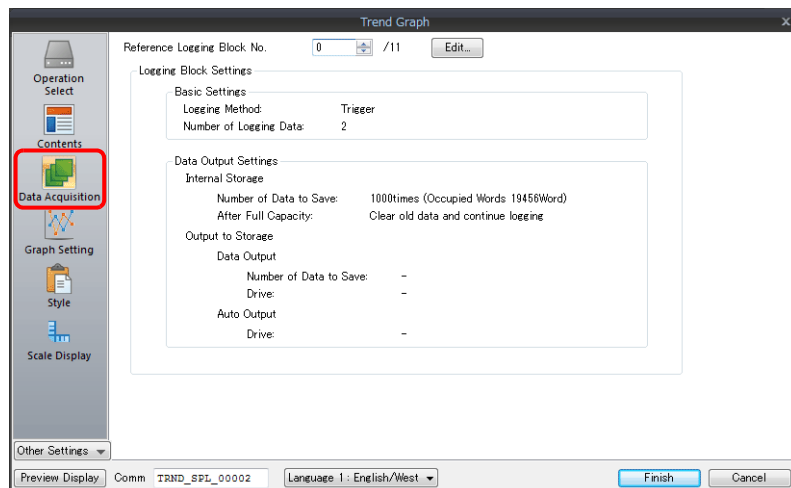

Item	Description	Setting Value
Reference Logging Block No.	Set the number registered to the logging server. The registration details are shown below.	0

Graph Setting

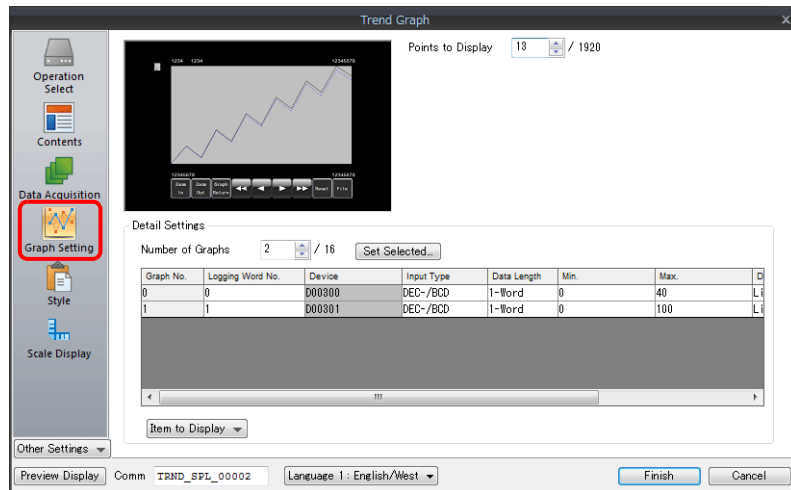

Item	Description	Setting Value
Points to Display	<p>Set the number of plot points along the horizontal axis.</p> <p>Direction: RGT</p> <p>Number of plotted points: 6</p> <p>Graph area</p> <p>Plot point pitch</p> <p>Graph origin</p> <p>[Points to Display]: 11</p>	13
Number of Graphs	Specify the number of graphs.	2

Item	Description	Setting Value	
		Graph 0	Graph 1
Logging Word No.	Specify which word the data corresponds to in the number of words specified for the logging server.	0	1
Input Type	Set the data format of the device memory.	DEC-/BCD	DEC-/BCD
Data Length	Set data length of the device memory.	1-Word	1-Word
Min./Max.	Set the minimum and maximum values for logging data.	0 to 40	0 to 100
Display Format	Set the line type or point type and color.	Line Graph	Line Graph
Type		Black solid line	Blue dotted line

[Set Selected] button
 This button is useful for setting the data length and minimum and maximum graph values at once for multiple graphs when these values are the same.

1. Specify the number of graphs.
2. Click [Set Selected] to display the [Set Selected] window.
3. Set [Data Length], [Graph Min. Value], and [Graph Max. Value] and click [OK]. These settings are applied to all graphs at once.

Style

Use [Adjust Position] to adjust the size of the display area.

([Select from catalogs] and [Add Parts] are not configured in this example.)

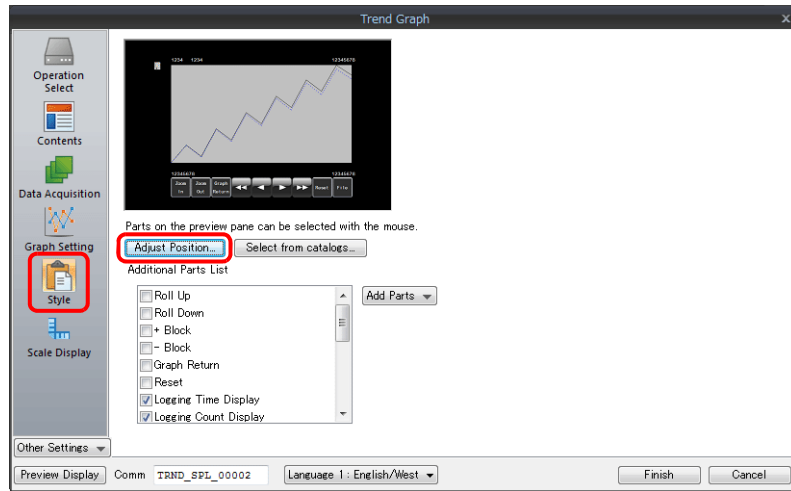

The graph area changes to the required display size according to the setting for the number of display points.

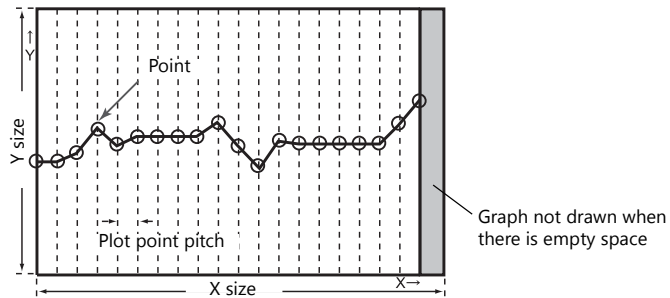

For this reason, size adjustment must be performed according to the following procedure.

1. Click [Adjust Position].
2. The screen changes and all parts become selected. Clear the selected state first and then select the display area only by clicking on it.

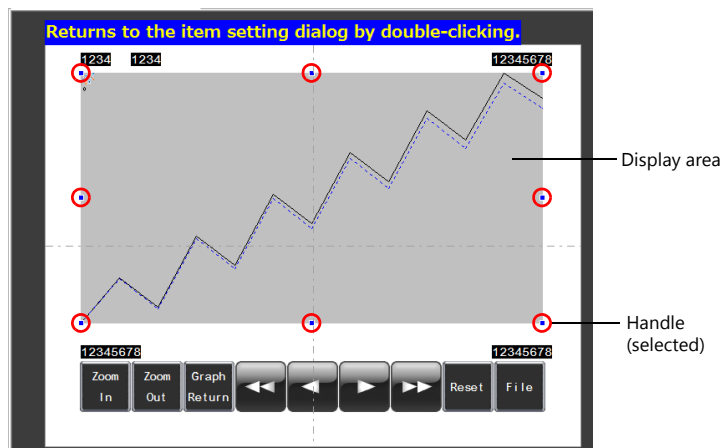

- Align the mouse cursor over the handle on the margin side to change the mouse cursor to \leftrightarrow .

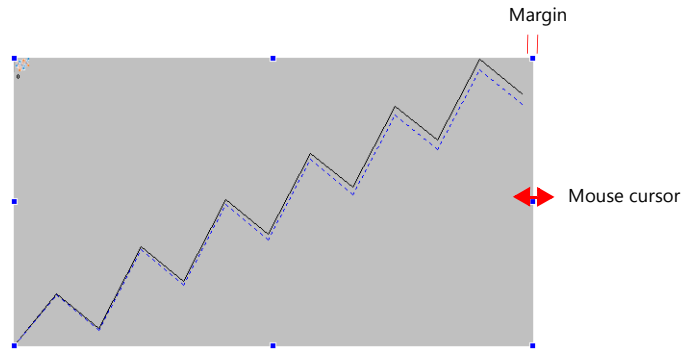

- Drag with the mouse cursor as \leftrightarrow . The size is adjusted automatically.

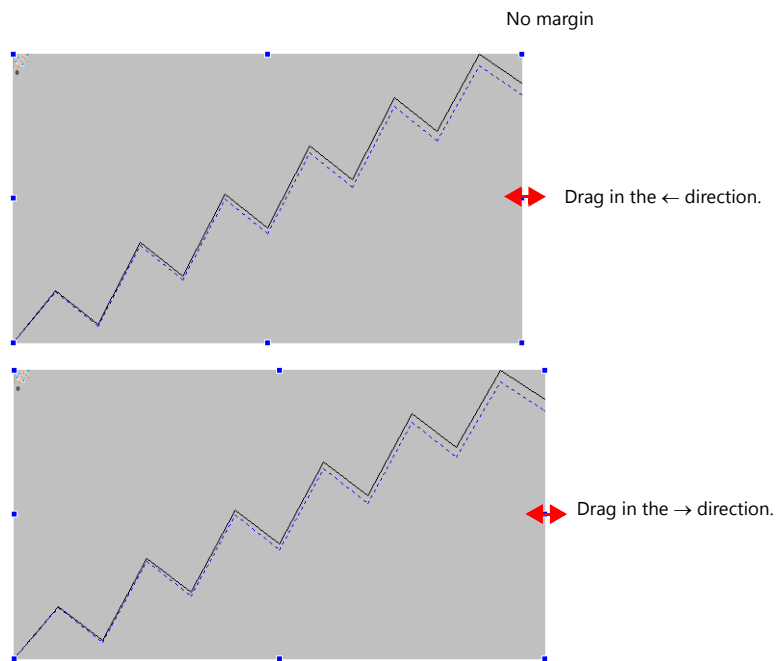

This completes size adjustment.

- Double-click to return to the settings window.

Scale Display

Graphs can display a scale along the right, left, top, or bottom sides.
 In this example, a scale is displayed on the left, right, and bottom sides.

* [Scale Display] is available under [Other Settings].

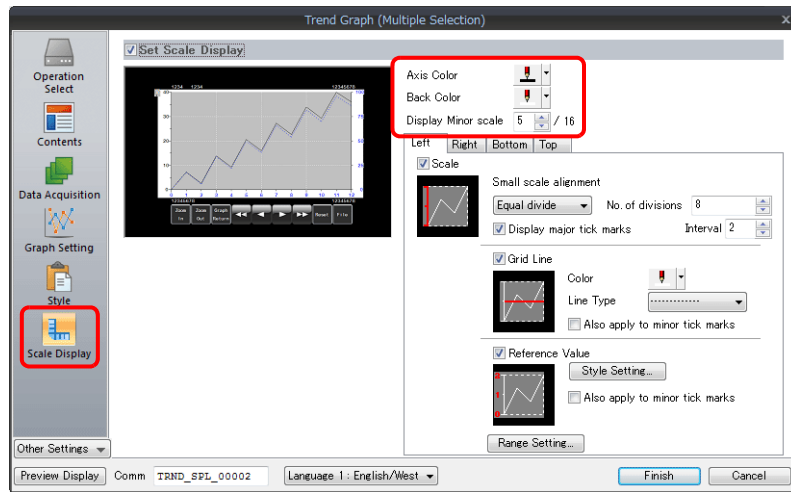

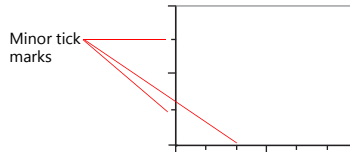

Item	Description	Setting Value
Set Scale Display	Select this checkbox to enable scale display.	Selected
Axis Color Back Color	Select the color of the major and minor tick marks, and axis lines of the scale. This setting is common to the background color for the left, right, bottom, and top sides.	Axis Color: Black Back Color: White
Display Minor scale	Set the length of the minor tick marks of the scale. Range: 1 to 16 This setting is common to all left, right, bottom, and top sides. The thickness of the markings is fixed.	5

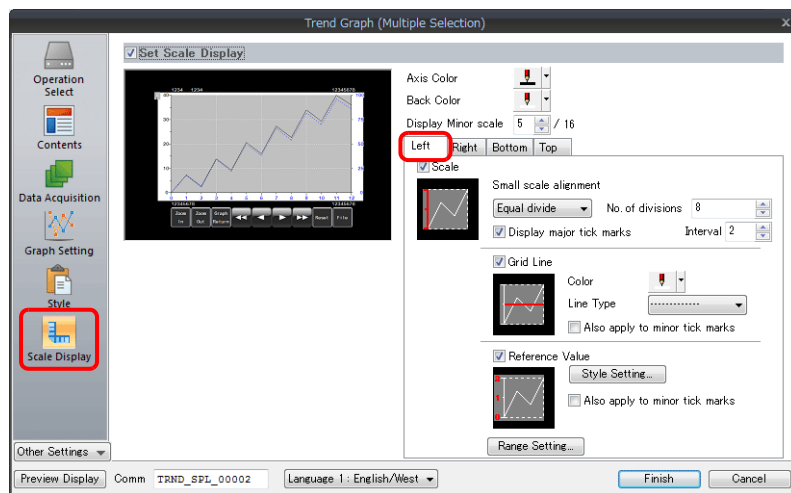

- [Left] tab

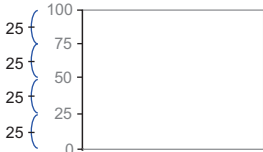
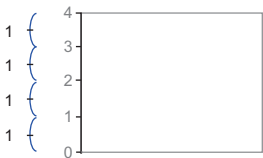
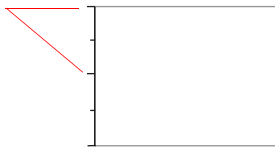

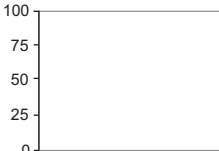
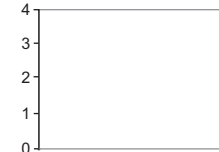
Item	Description	Setting Value
Scale	Set whether to show or hide the left side scale.	Selected
Small scale alignment	<ul style="list-style-type: none"> Equal divide (unit based on [No. of divisions]) Minor tick marks are equally spaced according to the set number of divisions along the axis line. No. of divisions: 4  Equal interval (unit based on [Interval]) Minor tick marks are spaced at the specified interval based on the range (maximum and minimum values of the specified graph or an arbitrary setting value) set under [Range Setting].*¹ Interval: 25 Graph 0 Graph Min. Value: 0 Graph Max. Value: 100  Interval: 1 Scale value: 0 to 4  	Equal divide, 8
Display major tick marks	<p>Select this checkbox to display major tick marks. Major tick marks are twice the length of minor tick marks. The thickness of lines is fixed.</p> <p>Major tick marks </p>	Selected Interval: 2
Grid Line Color Line Type Also apply to minor tick marks	<p>Select this checkbox to display grid lines at the positions of major and minor tick marks of the scale. Set the color and line type of grid lines. It is possible to only display grid lines at the positions of major tick marks.</p> <ul style="list-style-type: none"> Grid lines only at major tick marks  Grid lines at major/minor tick marks  	Selected White Dotted line Unselected
Reference Value Style Setting Also apply to minor tick marks	<p>Select this checkbox to display reference values based on the range (maximum and minimum values of the specified graph or an arbitrary setting value) set under [Range Setting].*¹</p> <p>Interval: 25 Graph 0 Graph Min. Value: 0 Graph Max. Value: 100 </p> <p>Interval: 1 Scale value: 0 to 4 </p>	Selected Digits: 3 Text Color: Black Also apply to minor tick marks: Unselected
Range Setting	<p>Refer to the setting of each option.</p> <p>* When the graph direction is [UP] or [DW], numbers are displayed based on the setting of [Points to Display] or [Set Value] under [Range Setting].</p>	Match with the specified graph No. 0

- [Right] tab

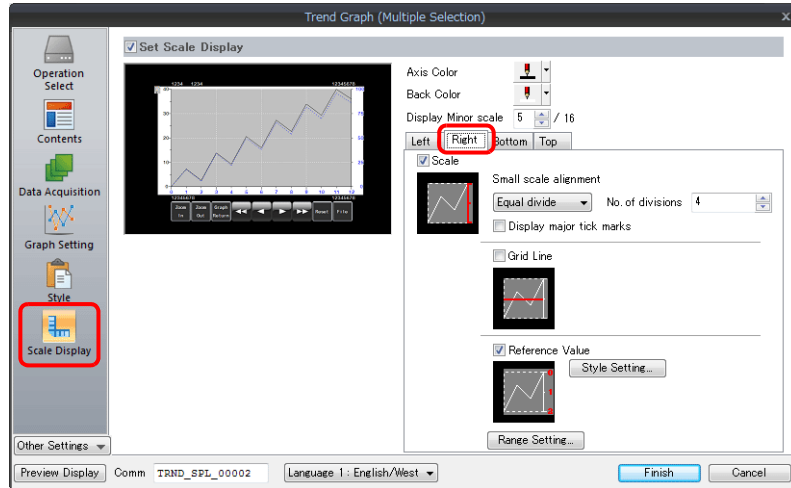

Item	Setting Value
Scale	Selected
Small scale alignment	Equal divide, 4
Display major tick marks	Unselected
Grid Line	Unselected
Reference Value	Selected
Style Setting	Digits: 3 Text Color: Blue Flush Right
Range Setting	Match with the specified graph No. 1

- [Bottom] tab

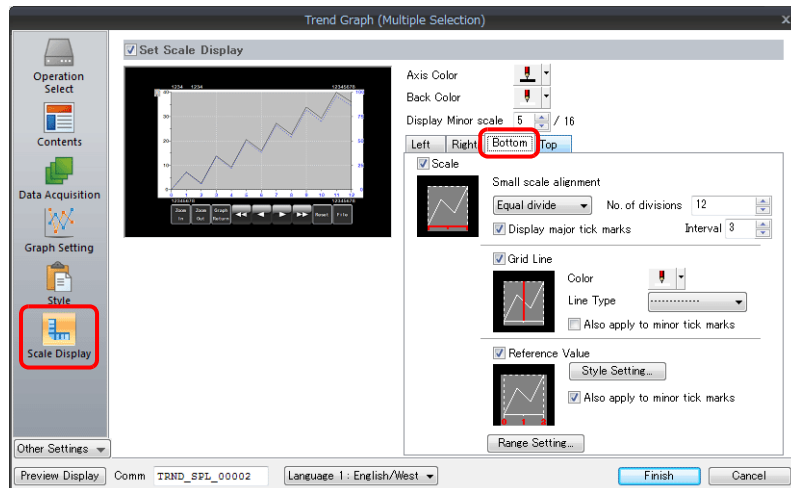

Item	Setting Value
Scale	Selected
Small scale alignment	Equal divide, 12
Display major tick marks	Selected Every 3 marks
Grid Line	Selected
Color Line Type Also apply to minor tick marks	White Dotted line Unselected
Reference Value	Selected
Style Setting Also apply to minor tick marks	Digits: 2 Text Color: Blue Also apply to minor tick marks: Selected
Range Setting	Match with the specified graph No. 1

- [Top] tab
These settings are not used in this example.

Click the [Complete] button.
This completes the configuration of settings.

Placing a Switch (for CSV/Backup File Output)

1. Click [Home] → [Switch] and place a switch on the screen.
2. Display the switch's settings window and configure the following settings.
 - Char. Prop.

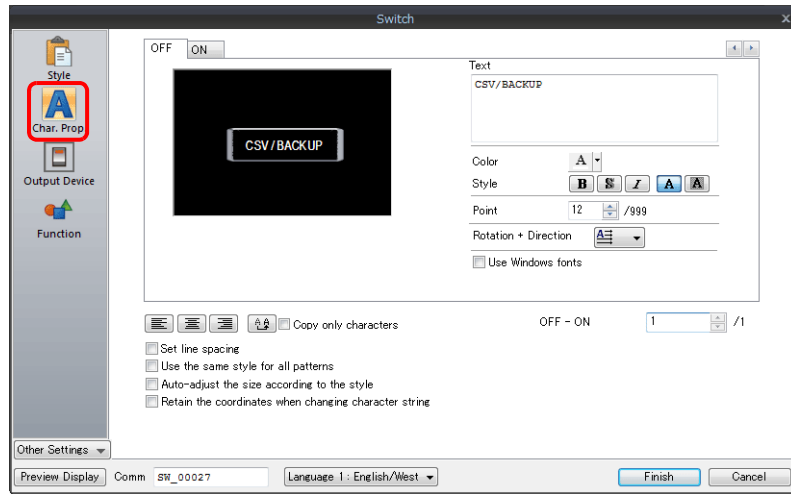

Item	Description	Setting Value
Text	Set the text to be displayed on the switch.	CSV/BACKUP

- Output Device

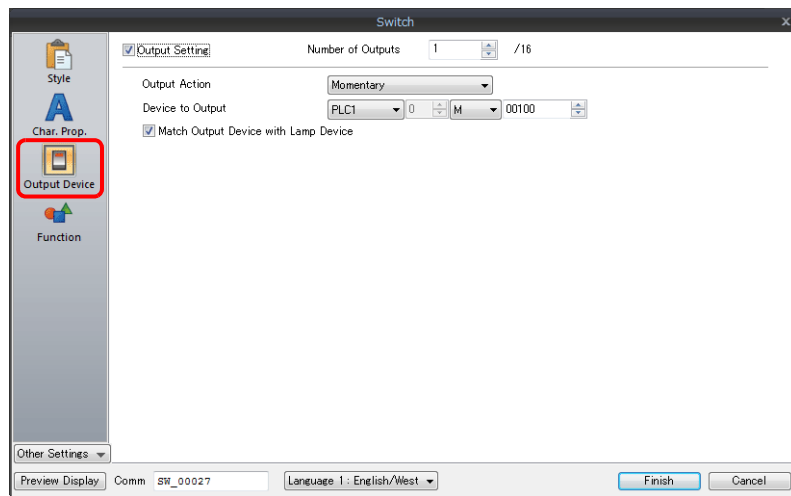

Item	Description	Setting Value
Output Setting	Data is output to device memory when the switch is pressed. A maximum of 16 outputs can be made.	Selected Number of Outputs: 1
Output Action	Set the write operation to perform with respect to the output memory device.	Momentary
Device to Output	Specify the output device memory address.	M100
Match Output Device with Lamp Device	Select this checkbox to set the same device memory for the output device memory and lamp device memory.	Selected

Click the [Complete] button.
This completes the switch creation process.

Placing Text and a Switch for Returning to the Menu Screen

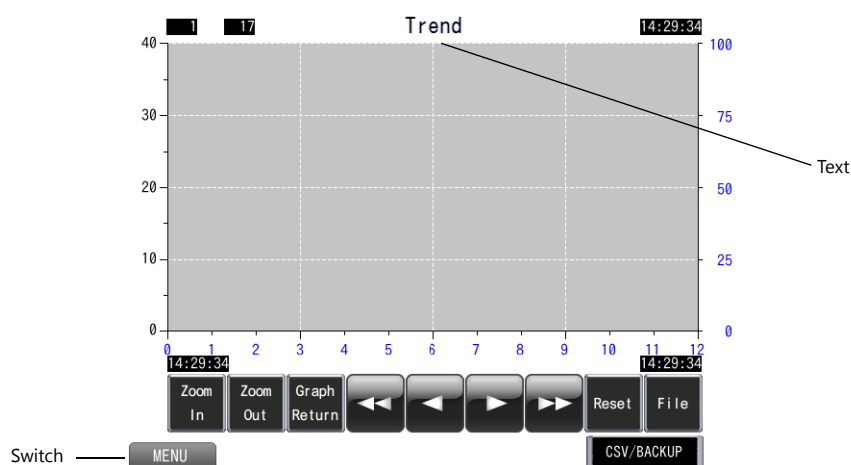

Text

Create a title for the screen.

1. Click [Home] → [Text] → [Text]. The mouse cursor changes to a crosshair.
2. Click on the screen. A text frame is displayed.
3. Enter text.
4. Click a location on the screen other than the text.
5. Click the text to display its item view window. Adjust the text color and size.

Switch

Create a switch for returning to the menu screen.

1. Click [Home] → [Switch] and place a switch on the screen.
2. Display the switch's settings window and set [Function] to "Screen Change-over" and [Switch to No] to "0".

This completes the screen creation process.

SRAM/Clock Setting

SRAM settings must be configured because SRAM was selected as the save destination of history data for data retention after the power is turned off.

Clock settings must also be configured because the clock display is set to use the internal clock of the V9 series unit.

1. Click [System Setting] → [Unit Setting] → [SRAM/Clock] to display the [SRAM/Clock Setting] window.

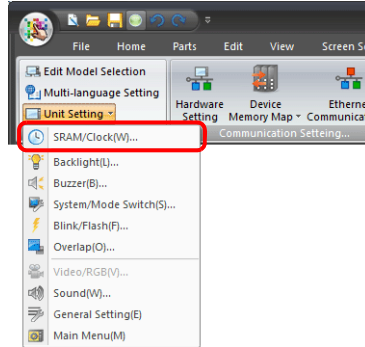

2. Configure the following settings. Do not change any of the other settings.

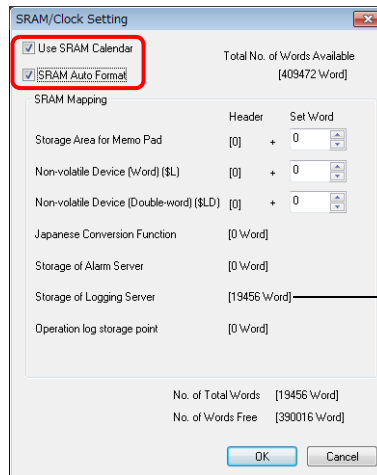

The amount of SRAM used by the logging server can be checked.

Item	Description	Setting Value
Use SRAM Calendar	Selected Use the built-in clock of the V9 series unit. Unselected Use the clock in the PLC.	Selected
SRAM Auto Format	Selected Automatically format the SRAM area. Unselected The following message is displayed when transferring the screen program. "Error: 161 (SRAM: x)" or "Error: 163 (SRAM: x)" Execute [SRAM Format] in Local mode. For the format procedure, refer to page 3-21.	Selected

This completes the necessary settings.

3.4 Checking Unit Operation

Check screen operation after transferring the screen program to MONITOUCH.

3.4.1 List of Used Device Memory Addresses

The device memory addresses used in this example are listed below.

Device Memory	Description	Remarks
M10	Trigger bit (control device memory)	
M100	Storage output bit	
D300	Graph No. 0 (logging word No. 0)	
D301	Graph No. 1 (logging word No. 1)	

3.4.2 Unit Operation

Check screen operation after transferring the screen program to MONITOUCH.

SRAM Format/Clock Setting

New units will display "Error: 161 (SRAM: x)" immediately after screen program transfer. In this case, format the SRAM area in Local mode.

The internal clock settings must also be configured in Local mode.

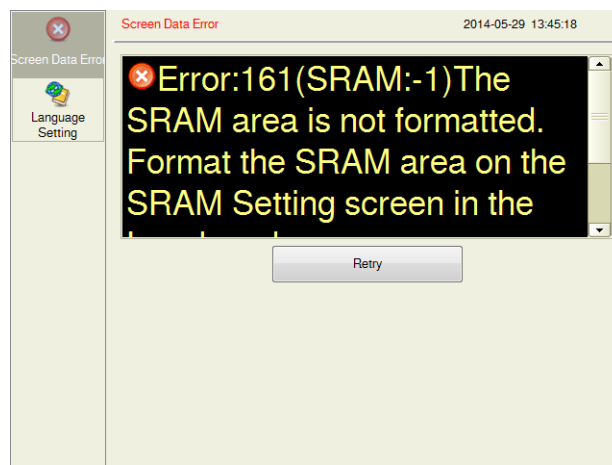

😊 Once the SRAM area of a unit is formatted, screen program transfers will not result in this error. ^{*1} While the unit is supplied with power or when power is turned off, data in SRAM is maintained as long as the battery lasts. If power to the unit is turned off when the battery is flat, data in SRAM will be lost. In this case, reformat the SRAM area.

Error occurs		Normal
SRAM		SRAM
Unformatted (New unit/flat battery)	Perform formatting (in Local mode)	\$L
	→	\$LD
		Internal storage setting
		Not used

^{*1} When the [SRAM Auto Format] checkbox is selected in the [SRAM/Clock Setting] window.

SRAM Format Procedure

1. Press the [SYSTEM] function switch and press the [Local] switch on the system menu.

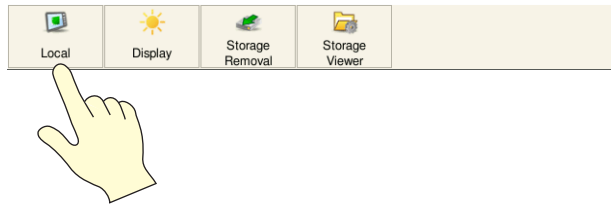

2. MONITOUCH switches to Local mode. Press [SRAM Setting] on the left of the screen.

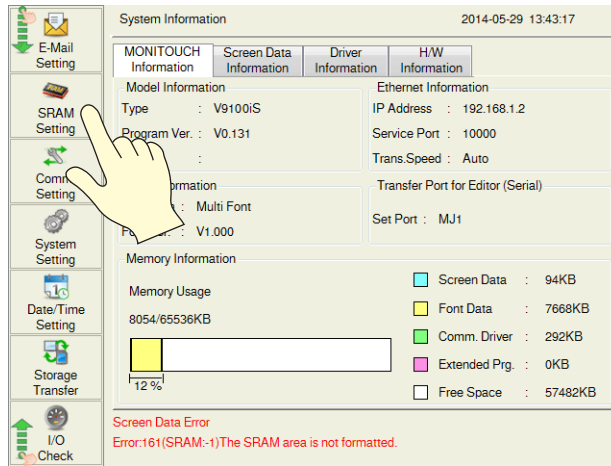

3. The SRAM Setting screen is displayed. Press [Format] and then [Execute].
A message that indicates that formatting is complete is displayed.

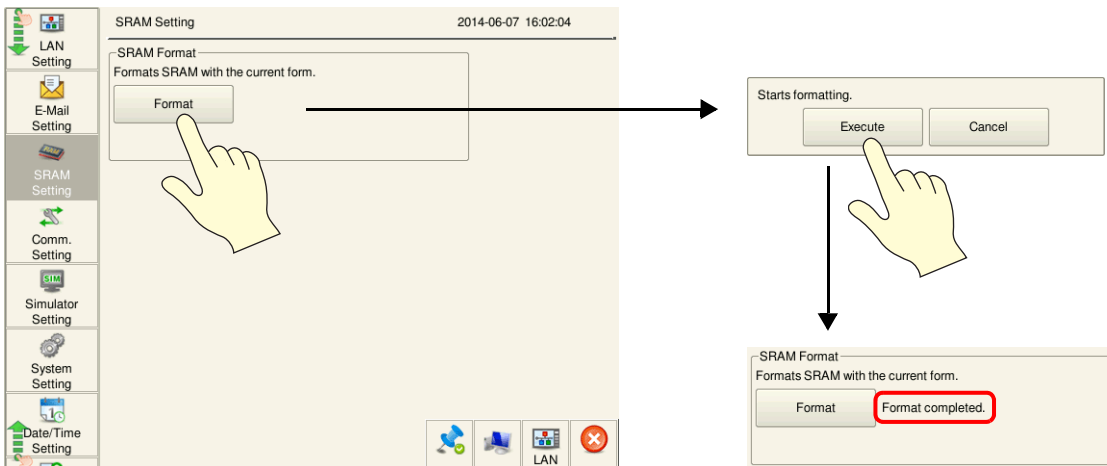

This completes the SRAM formatting process.

Clock Settings

1. Press the [SYSTEM] function switch and press the [Local] switch on the system menu.

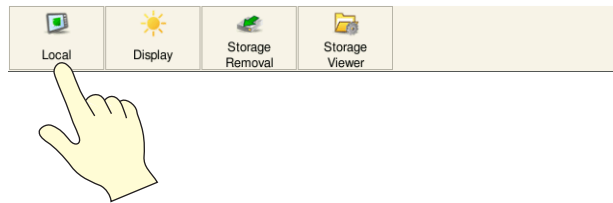

2. MONITOUCH switches to Local mode. Press [Date/Time Setting] on the left of the screen.

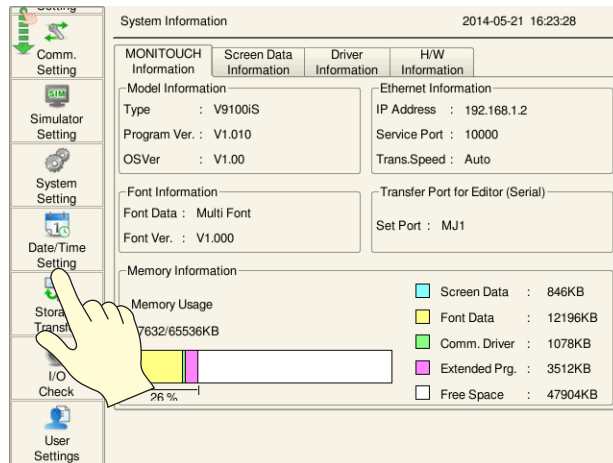

3. The Date/Time Setting screen is displayed. Set the correct date and time and press [Set].
The internal clock of the V9 series unit is updated and the time at the upper right of the screen is also updated.

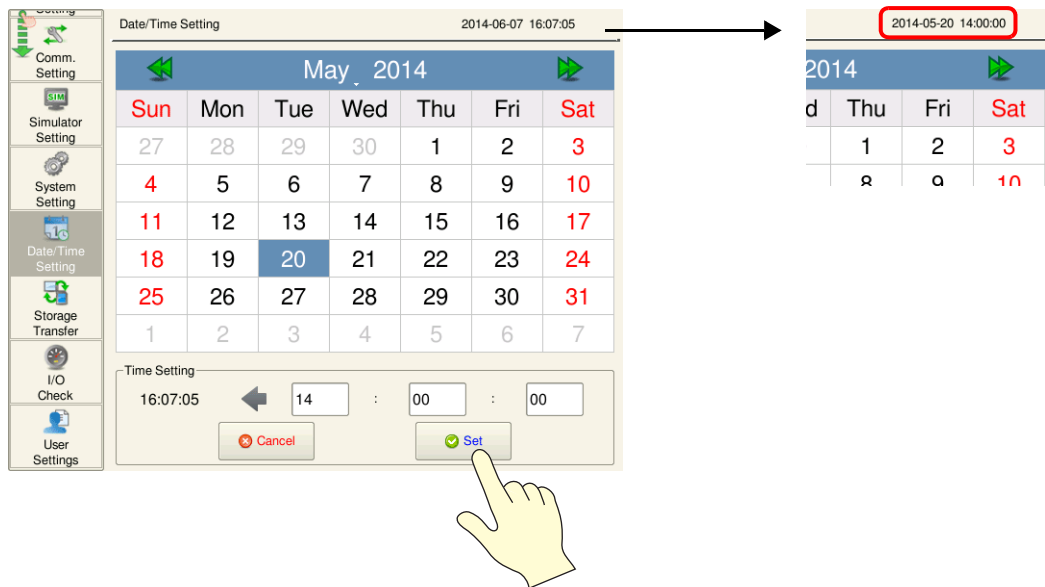

This completes the clock settings.
Press [RUN] on the left of the screen and display the trend screen.

Executing Logging

1. Enter the following constants for D00300 and D00301.
 - D00300 = 17
 - D00301 = 90
2. Turn ON the M00010 trigger bit (0 → 1).
The logging time and logging count are displayed as shown in the following figure.

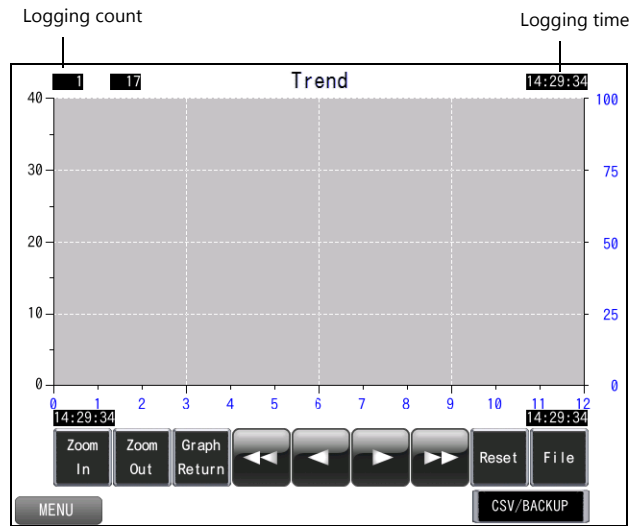

3. Turn OFF the M00010 trigger bit (1 → 0).
4. Turn ON the M00010 trigger bit (0 → 1) again.
The trend graph is displayed. The logging time is updated as shown in the following figure and the logging count displays "2".

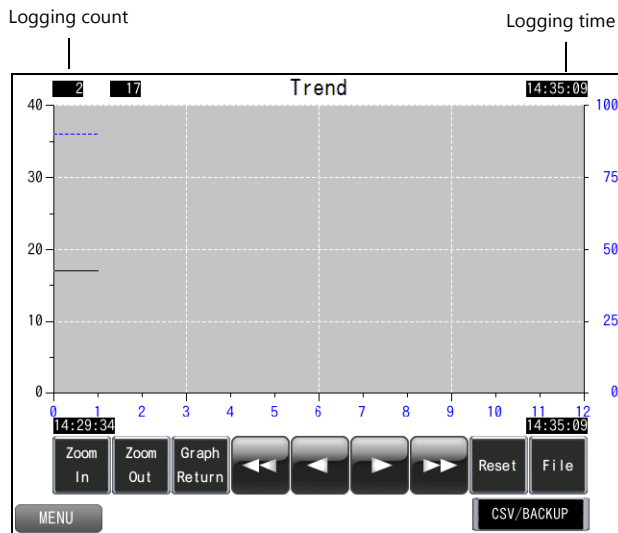

5. Continue to log the following data.

Logging count	Logging data device memory	
	D300	D301
3	16	65
4	16	70
5	15	75
6	15	80
7	16	70
8	17	65
9	18	60
10	19	55
11	20	50
12	21	45
13	22	40
14	25	38
15	24	40
16	23	45
17	22	50
18	21	55

Display example of logging count 18

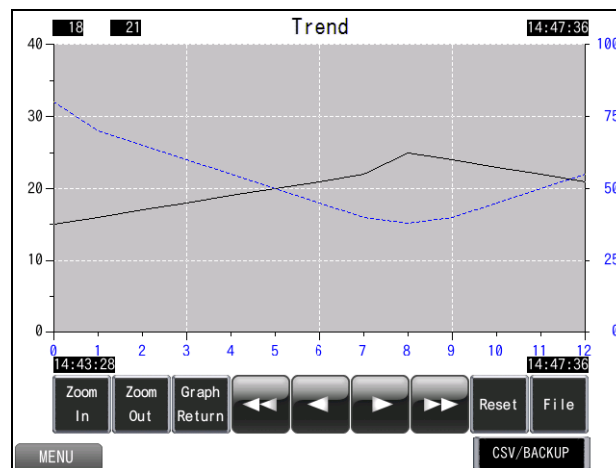

Checking History Data

Check history data according to the following procedure.

Scroll

1. Tap the display area.
The cursor is displayed at the tapped location and the graph return switch starts flashing at the same time.
2. Scrolling updates the graph.

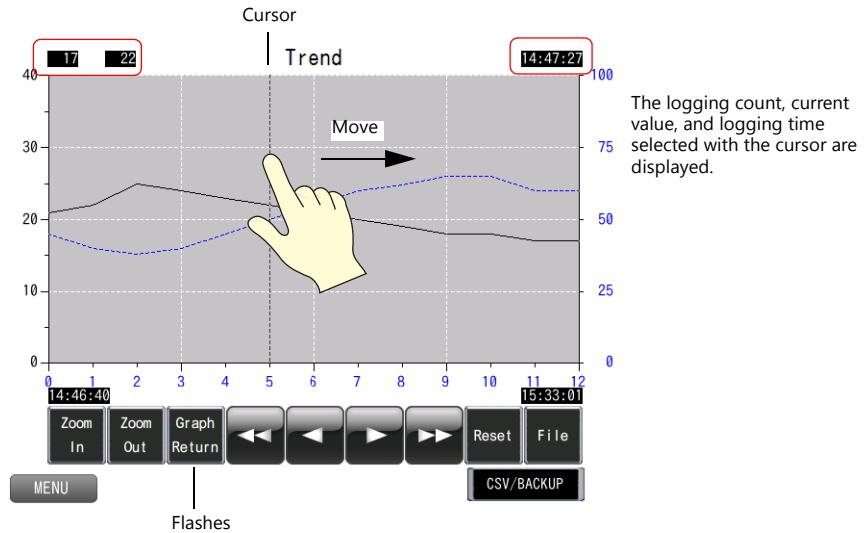

3. Press the [Graph Return] switch to hide the cursor and return to the latest display state.

Roll up/roll down switches

1. Press the roll up or roll down switch.
The cursor is displayed and the graph return switch starts flashing at the same time.

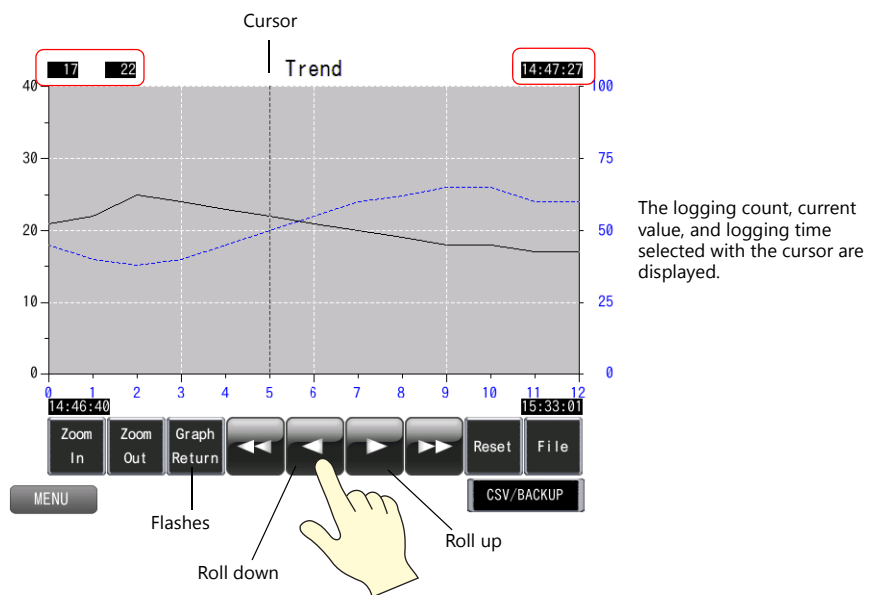

2. Press the roll up or roll down switch again. The cursor moves and the logging count, currently selected value, and logging time are updated.
3. Press the [Graph Return] switch to hide the cursor and return to the latest display state.

Checking CSV/Backup Output

Output history data as a CSV/backup file on a storage device.
The output file can be loaded to check past history data.

CSV/backup output

1. Press the [CSV/BACKUP] switch.

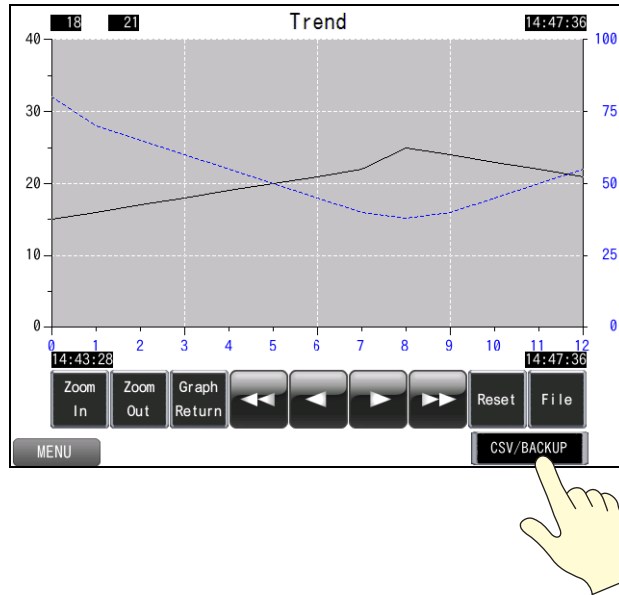

Storage output bit
M100 changes from 0 to 1

2. Press the [SYSTEM] function switch and press the [Storage Viewer] switch on the system menu.

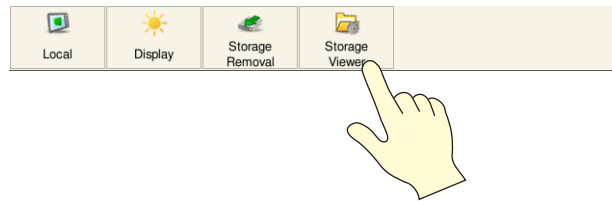

3. The storage viewer is displayed.
Tap the "EXT0000" folder and then tap the "LOGGING" folder.
Check that a CSV and backup folder have been created.

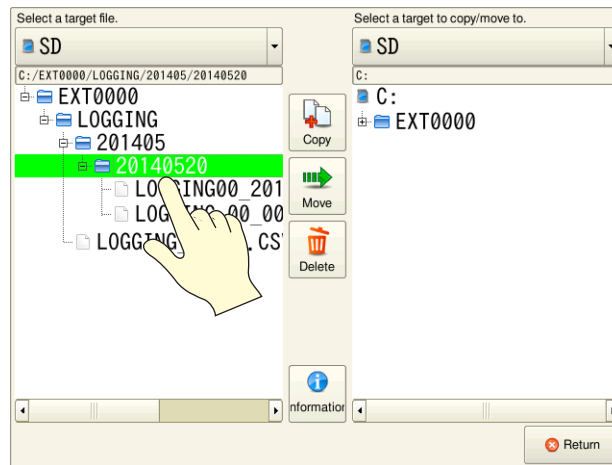

4. Press the [Return] switch.

- Continue on from the current data to logging of the following data. (Turn ON the M00010 trigger bit.)

Logging count	Logging data device memory	
	D300	D301
19	20	60
20	19	62
21	18	65
22	18	65
23	17	60
24	17	60

Display example of logging count 24

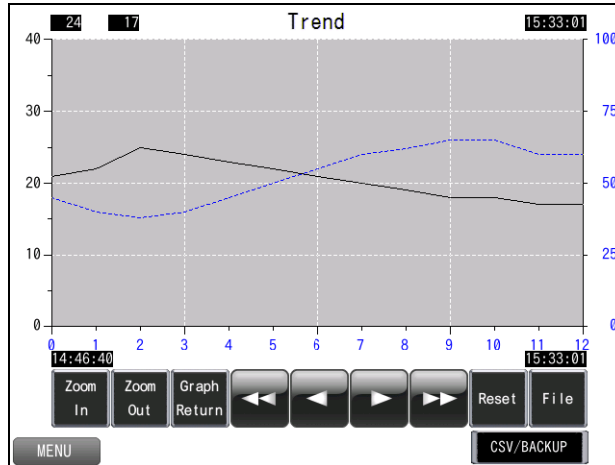

- Press the [CSV/BACKUP] switch again.

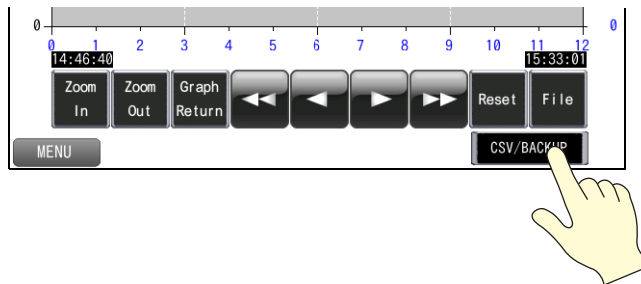

- Press the [SYSTEM] function switch and press the [Storage Viewer] switch on the system menu. Check that the date of the CSV file is updated and a new backup file has been created.

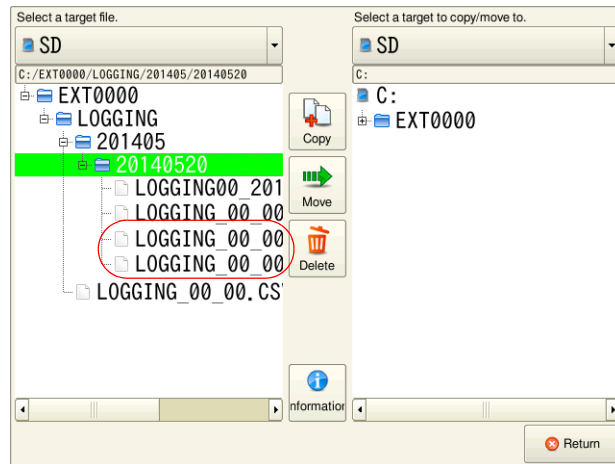

Backup File Graph Display

Select a backup file saved to a storage device for graph display.

1. Press the [File] switch.

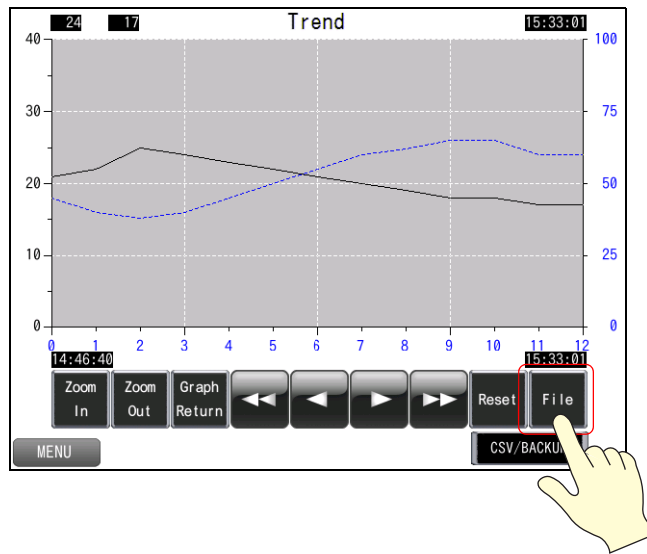

2. Select a time file in the date folder and press the [Open Log File] switch.

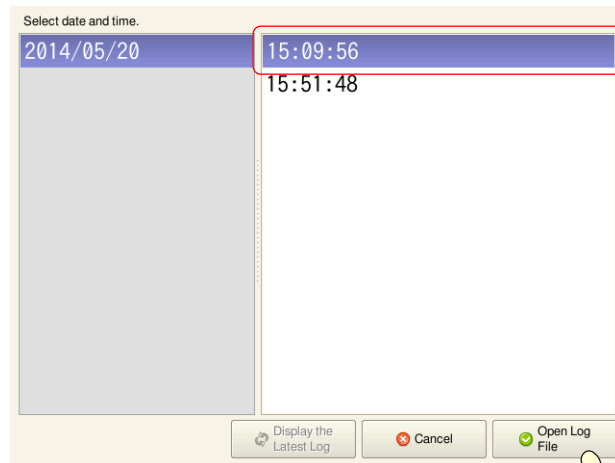

Two backup files are on the storage device.

A graph for the selected file is displayed.

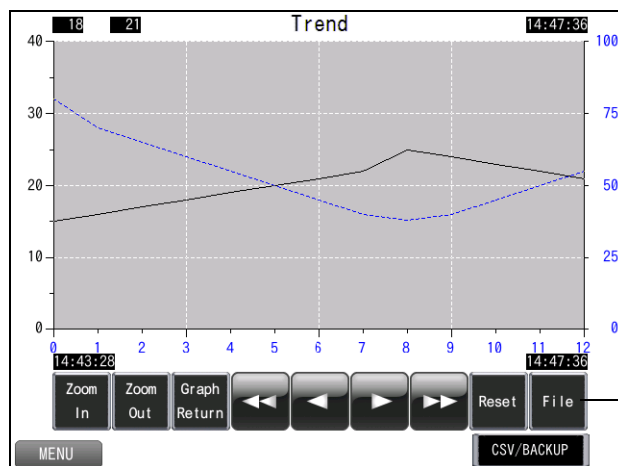

3. To return to the current graph, press the [File] switch and then press the [Display the Latest Log] switch. The [File] switch stops flashing and the graph display changes to the latest state.

Enlarging and Reducing Part Size

Press the [Zoom In] switch to enlarge the display of the latest data (end point) by 2 times.
 The display is enlarged by 4 times and then 8 times upon each consecutive switch press.
 Press the [Zoom Out] switch to change the display in the order of 8 times, 4 times, 2 times, and then actual size.

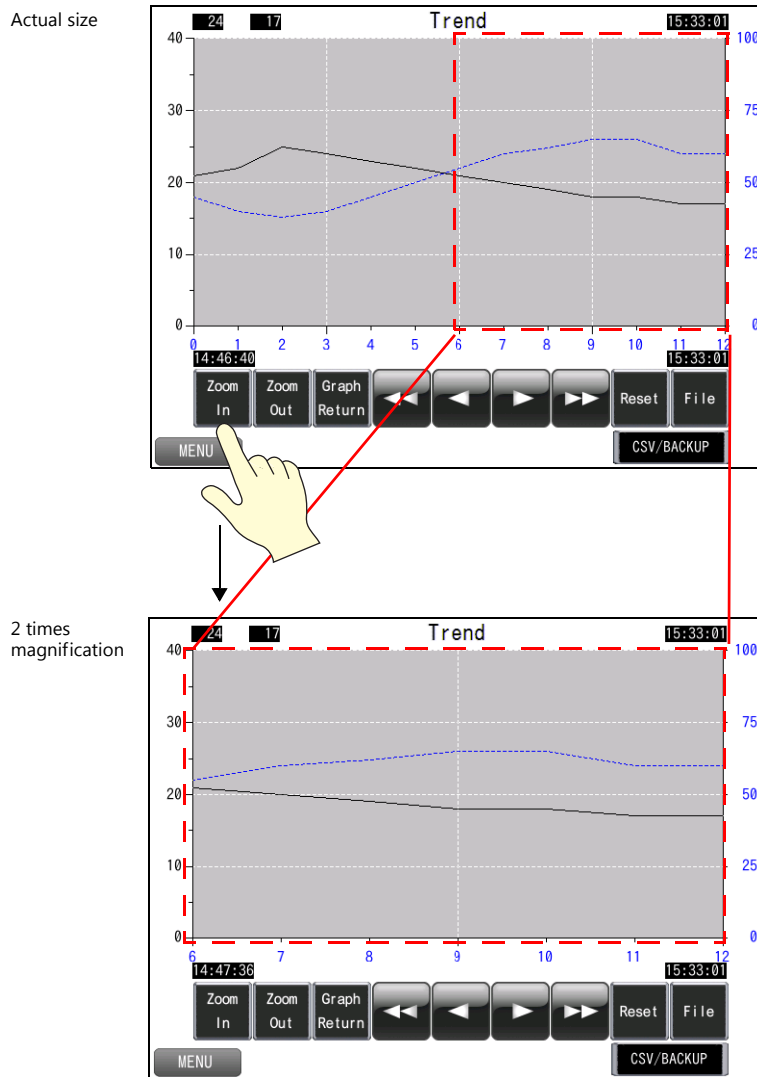

If the cursor is displayed, magnification centers on the cursor.

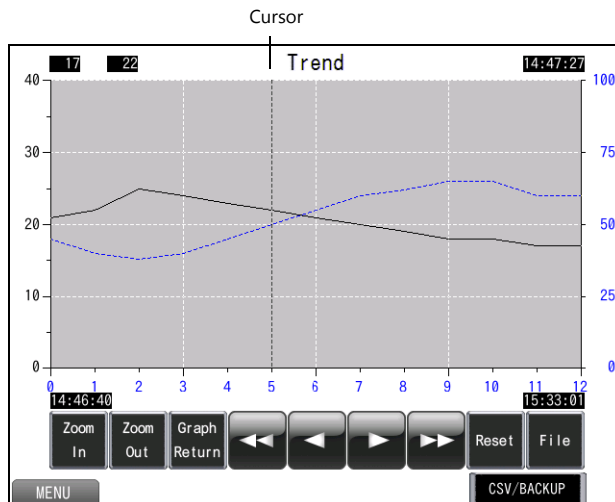

The logging count, current value, and logging time selected with the cursor are displayed.



In addition to enlarging the graph area, the entire screen can also be enlarged. For more information, refer to "10.1 Zoom in".

4 Recipe

4.1 Overview

Recipes

Recipes allow product type information and conditions required for manufacturing on the factory floor to be read by a PLC and configured and changed as necessary.

Product type information and conditions (recipe data) is stored in a CSV file or BIN file on a storage device in advance.

Multiple files can be stored at once and the required file can be selected and written to a PLC.

Recipes can be executed by using a switch, as well as by turning a bit ON or OFF.

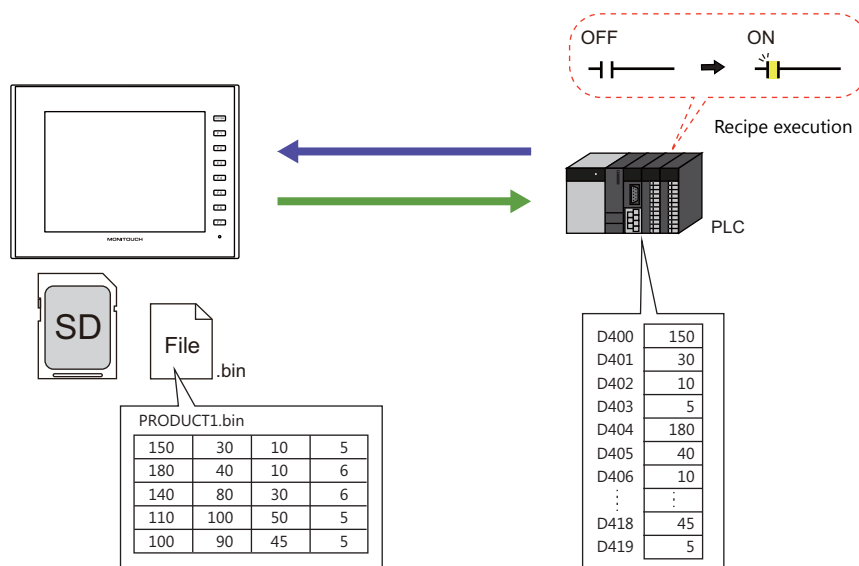

- Data can also be read in units of records.

The diagram shows a table with five records for different products (APPLE, ORANGE, GRAPE, LEMON, PEACH) and their corresponding values for columns A, B, C, and Data G. The table also includes a 'Type D' row and a 'Gross' row. Arrows point to the 'Data titles' (A, B, C, Data G) and the 'Five records'.

	A	B	C	Data G
APPLE	60	110	250	3
ORANGE	60	110	220	10
GRAPE	50	85	240	8
LEMON	40	60	220	11
PEACH	80	120	240	15
Type D		2200	1500	8
Gross		1100	1200	1000

- CSV and BIN files can be easily created and edited using the screen configuration software.

4.2 Screen Example

This chapter explains how to create a "PRODUCT1.bin" file and a screen that can transfer recipe data between this BIN file on a storage device and addresses D400 to D419.

Screen 2

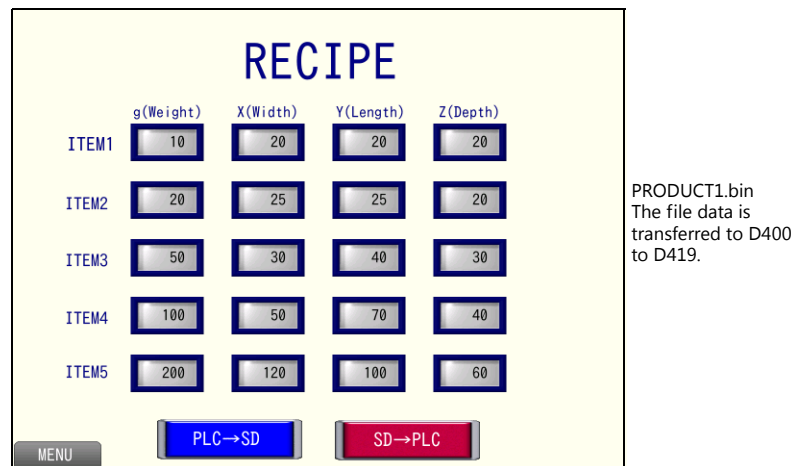
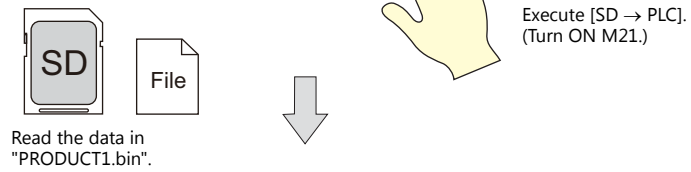
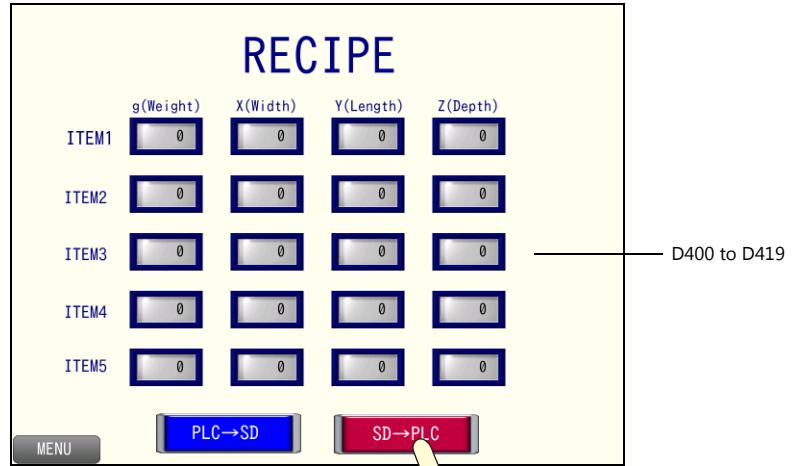

4.3 Screen Creation

4.3.1 Recipe Settings

Configure the required recipe settings.

1. Click [System Setting] → [Recipe] and click [OK] for No. 0. The [Recipe[0]] window is displayed.
2. Configure settings on the following tab windows in order.
 - [Standard Operation] tab

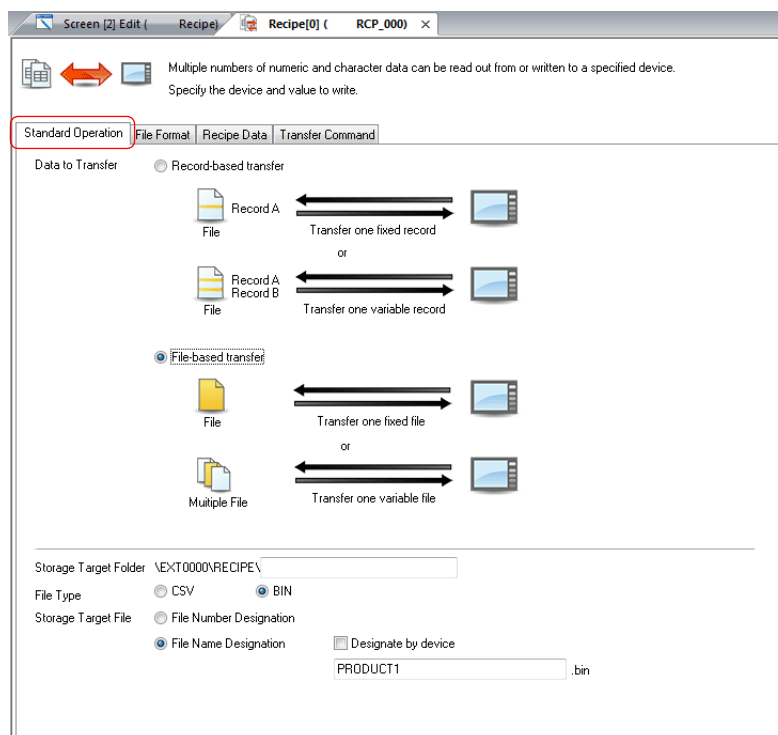

Item	Description	Setting Value
Data to Transfer	Record-based transfer Read and write recipe data in units of records (rows or columns). File-based transfer Read and write recipe data in units of files.	File-based transfer
Storage Target Folder	Set the storage destination of the recipe file. Define one folder per recipe setting. Blank: In the "RECIPE" folder xxxx: In the "xxxx" folder	Blank
File Type (CSV/BIN *)	Select the file type of the recipe.	BIN
Storage Target File	File Number Designation (0 to 9999) Set the file number of the storage target. Device memory can also be specified. File Name Designation Set the filename of the storage target. Device memory can also be specified.	File Name Designation PRODUCT1.bin

- [File Format] tab

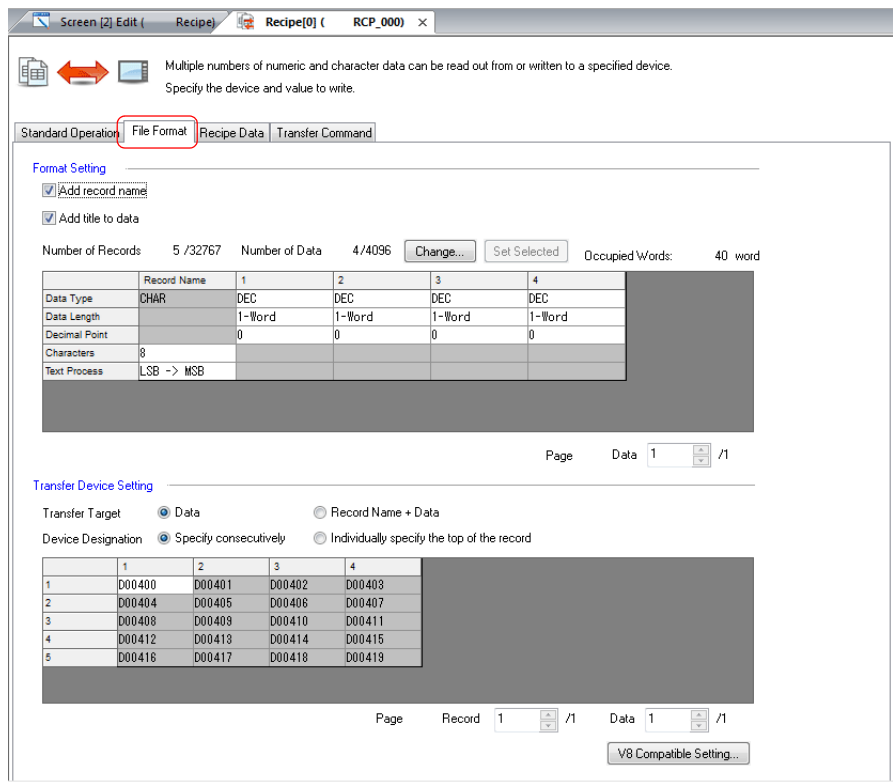

- Format Setting

Item	Description	Setting Value																
Add record name	Add record names to the first column. 2 to 255 characters. <table border="1" style="margin-left: 20px;"> <tr><td>APPLE</td><td>60</td><td>110</td><td>250</td></tr> <tr><td>ORANGE</td><td>60</td><td>110</td><td>220</td></tr> <tr><td>GRAPE</td><td>50</td><td>85</td><td>240</td></tr> </table>	APPLE	60	110	250	ORANGE	60	110	220	GRAPE	50	85	240	Selected				
APPLE	60	110	250															
ORANGE	60	110	220															
GRAPE	50	85	240															
Add title to data	Add titles to the first row. <table border="1" style="margin-left: 20px;"> <tr><td></td><td>Agitation</td><td>Sterilization</td><td>Cooling</td></tr> <tr><td>APPLE</td><td>60</td><td>110</td><td>250</td></tr> <tr><td>ORANGE</td><td>60</td><td>110</td><td>220</td></tr> <tr><td>GRAPE</td><td>50</td><td>85</td><td>240</td></tr> </table>		Agitation	Sterilization	Cooling	APPLE	60	110	250	ORANGE	60	110	220	GRAPE	50	85	240	Selected
	Agitation	Sterilization	Cooling															
APPLE	60	110	250															
ORANGE	60	110	220															
GRAPE	50	85	240															
Number of Records	Set the number of records using the [Change] button.	5																
Number of Data	Set the number of data entries per record using the [Change] button.	4																
Record Name Characters Text Process	Set the record name format.	8 LSB → MSB																
Data 1 to 4 Data Type Data Length Decimal Point	Set the data format.	DEC 1-Word 0																

- Transfer Device Setting

Item	Description	Setting Value
Transfer Target	Only configurable when the [Add record name] checkbox is selected. Data Only transfer data. Record Name + Data Transfer record names and data.	Data
Device Designation	Available when [Standard Operation] → [File-based transfer] is selected. Specified consecutively Assigned consecutively from the top device memory address. Individually specify the top of the record Specify the top device memory address of each record and assign subsequent addresses consecutively.	Specified consecutively
Device memory addresses	Available when [Standard Operation] → [File-based transfer] is selected. Specify the device memory address of the transfer destination.	D400 (D400 to D419)

- [Recipe Data] tab
Click [Create File]. A new "PRODUCT1.bin" file is opened.
Edit the data in the file.

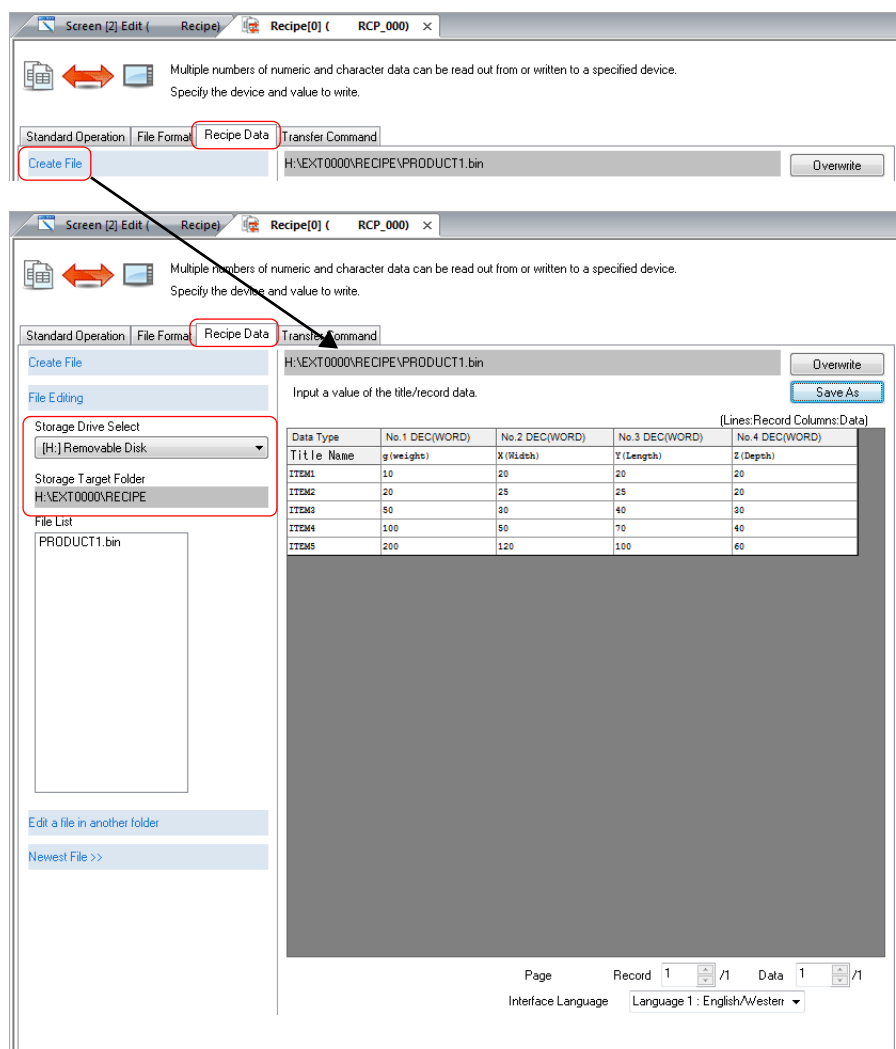

Item	Description	Setting Value
Storage Drive Select	Select the drive of the SD card/USB flash drive connected to the PC.	Depends on PC in use
Storage Target Folder	Displays the storage destination of the recipe file.	(Drive)\EXT0000\ RECIPE
Title Name Record name Data value No. 1 to 4	The data in the file can be edited.	See the following figure.

Data Type	No.1 DEC(WORD)	No.2 DEC(WORD)	No.3 DEC(WORD)	No.4 DEC(WORD)
Title Name	g(weight)	X(Width)	Y(Length)	Z(Depth)
ITEM1	10	20	20	20
ITEM2	20	25	25	20
ITEM3	50	30	40	30
ITEM4	100	50	70	40
ITEM5	200	120	100	60

Record name Data values of No. 1 to 4

After editing, click [Save As] to save "PRODUCT1.bin".
 "PRODUCT1.bin" is created in the "(Drive)\EXT0000\RECIPE" folder.

- [Transfer Command] tab

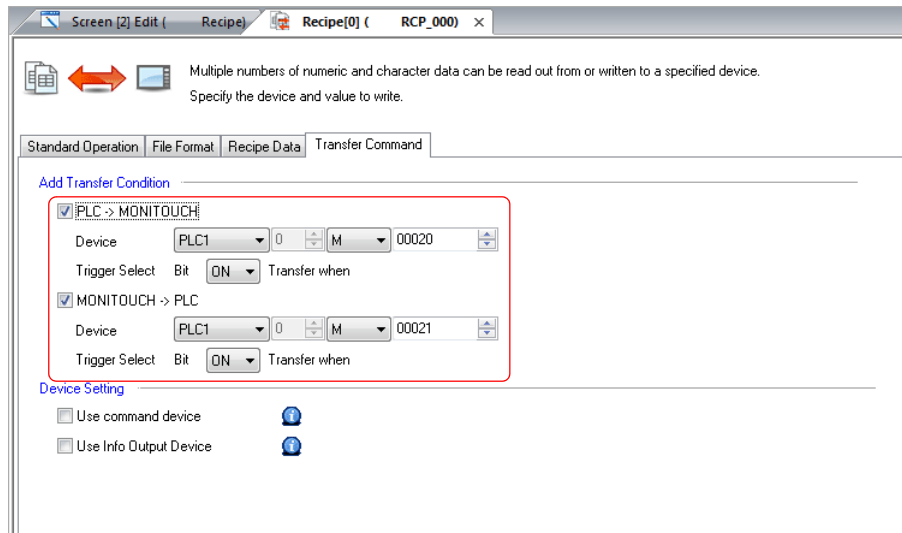

- Add Transfer Condition

Item	Description	Setting Value
PLC → MONITOUCH	Transfer data in PLC device memory to the recipe file (storage device = MONITOUCH). Transfer when bit ON: 0 → 1 Transfer when bit OFF: 1 → 0	Selected Device: M20 Transfer when bit ON
MONITOUCH → PLC	Transfer recipe file data (storage device = MONITOUCH) to the PLC device memory. Transfer when bit ON: 0 → 1 Transfer when bit OFF: 1 → 0	Selected Device: M21 Transfer when bit ON

- Device Setting

These settings are not used in this example.



Record-based transfer

When reading or writing to a PLC using record number or record name specification, configure the following settings.

Example: Read "PRODUCT2.bin" and record numbers using device memory specification

- D800: Record number specification
- D450 to D452: Data read target

PRODUCT2.bin

		Agitation	Sterilization	Cooling	Title Name
Record No. 1	APPLE	60	110	250	
Record No. 2	ORANGE	60	110	220	
Record No. 3	GRAPE	50	85	240	
Record No. 4	LEMON	40	60	220	
Record No. 5	PEACH	80	120	240	

Record Name

- [Standard Operation] tab

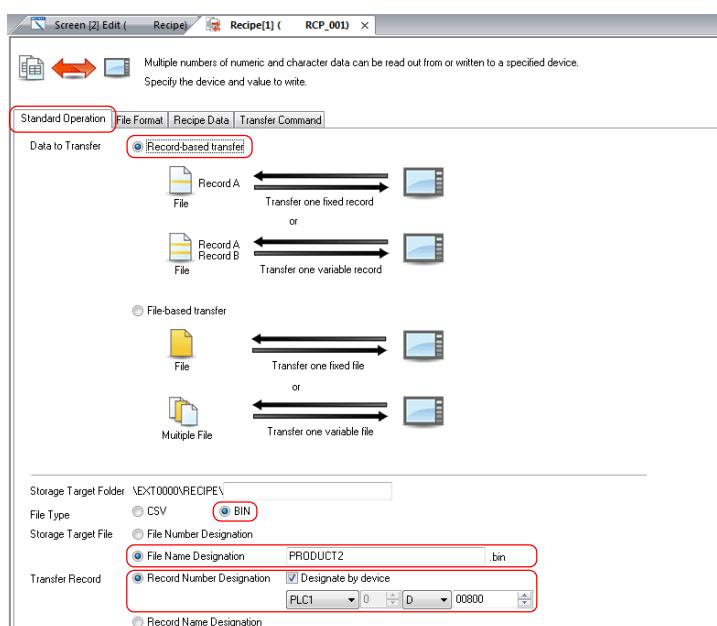

- [File Format] tab

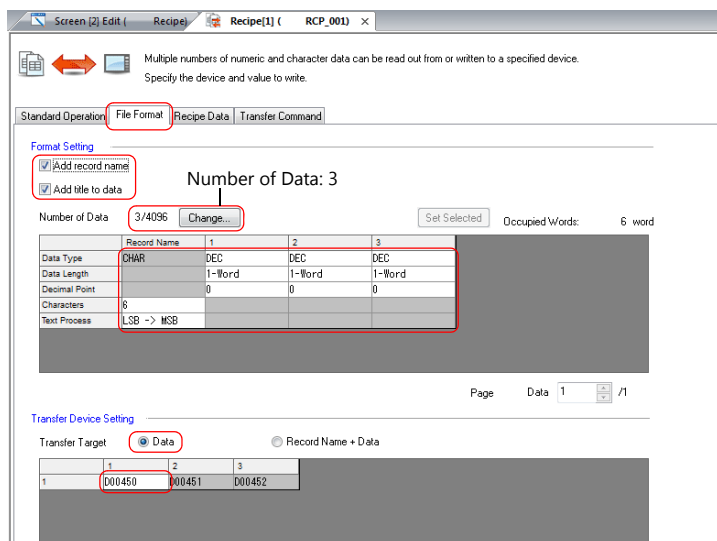

Continues on next page →





→ Continued from previous page

- [Recipe Data] tab: Create, edit, and save the "PRODUCT2.bin" file

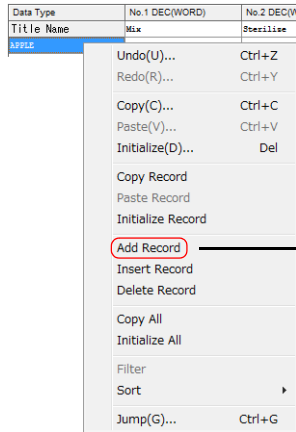

Right-click menu → [Add Record]

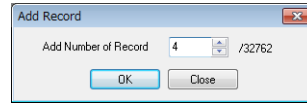

Add Number of Record: 4

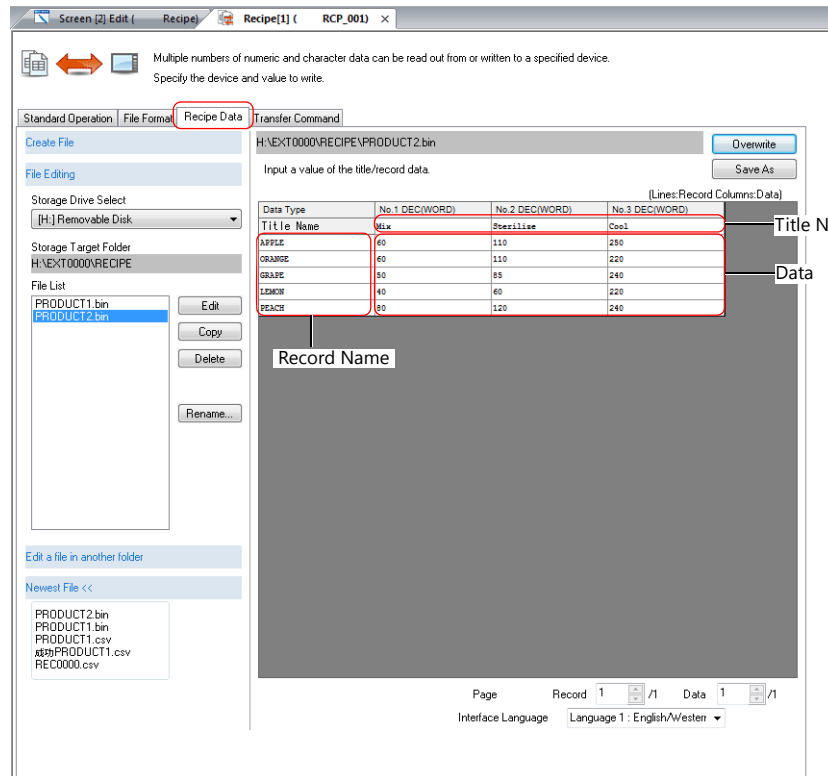

- [Transfer Command] tab: [MONITOUCH → PLC], M22, Transfer when bit ON

This completes the necessary settings.

When the D800 device memory address (for specifying the record number) is set to 2 and M22 is turned ON, the values of 60, 110, and 220 are transferred to D450, D451, and D452 respectively.

4.3.2 Screen Editing

Placing Numerical Data Display Parts

1. Click [Home] → [Data Display] → [Num. Display] and place a numerical data display part on the screen.
2. Display the numerical data display's settings window and configure the following settings.
 - Contents

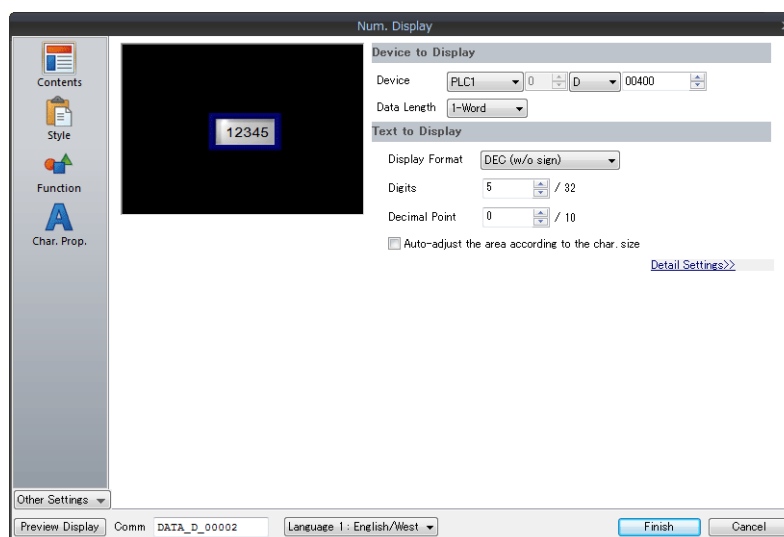

Item	Description	Setting Value
Device to Display	Specify the device memory address for monitoring.	D400

- Function

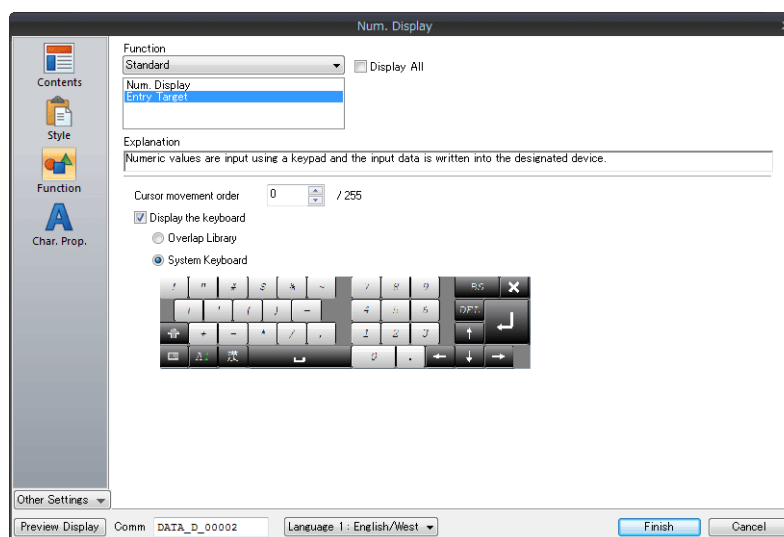

Item	Description	Setting Value
Function	Set the function to use.	Standard: Entry Target
Cursor movement order	Set the order to move the cursor when the UP/DW keys on the keypad are pressed.	0
Display the keyboard	Available when "Standard" and "Entry Target" are selected. The keypad calling function is added.	Selected System Keyboard

3. Click the [Complete] button.
4. Select the numerical data display part and click [Edit] → [Multi-copy]. The [Multi Copy] window is displayed.

- Configure the following settings and click [OK].

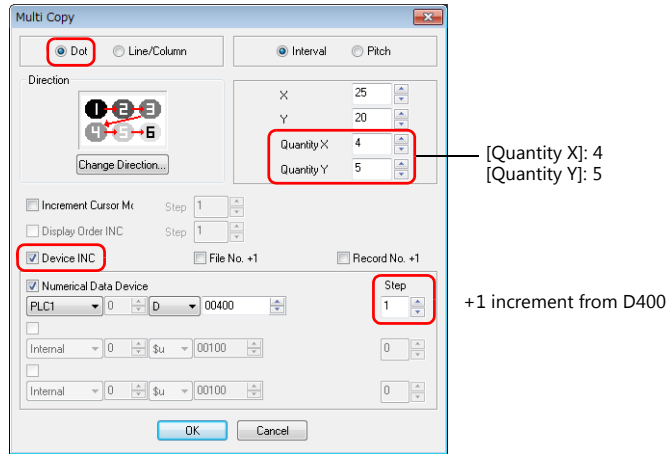

- This creates 20 copies of the numerical data display.
 Select the [View] → [Display Environment] group → [Device] checkbox to display the device memory address at the lower left of each numerical data display.
 Check that D400 to D419 are assigned.

This completes the necessary settings.

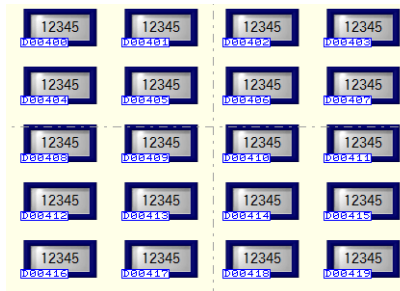

Placing Switches

1. Click [Home] → [Switch] and place a switch on the screen.
2. Display the switch's settings window and configure the following settings.
 - Style
Select the design and color.
 - Char. Prop.
Select the design and color.

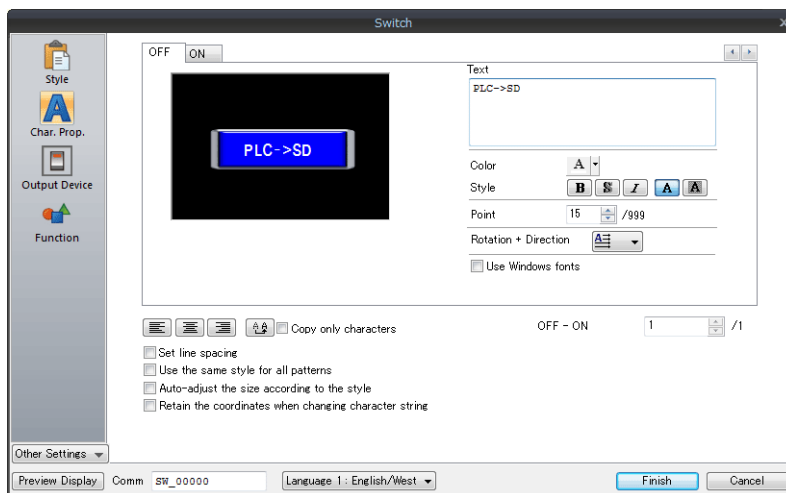

Item	Description	Setting Value
Text	Set the text to be displayed on the switch.	PLC → SD

- Function

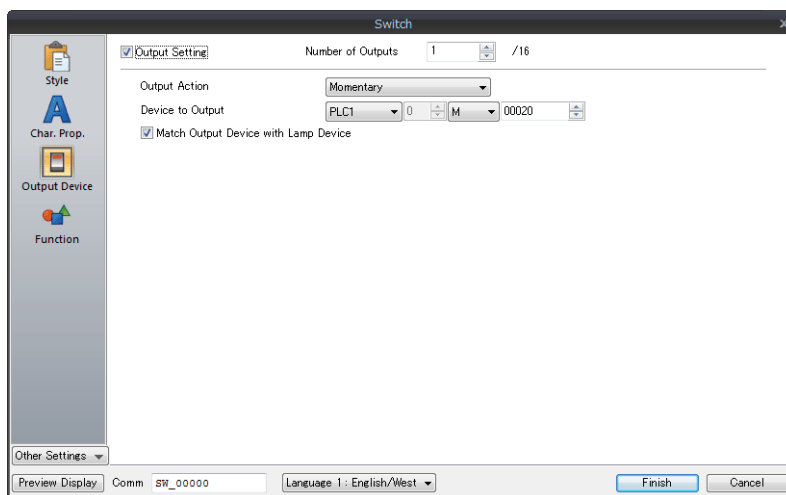

Item	Description	Setting Value
Output Setting	Data is output to device memory when the switch is pressed. A maximum of 16 outputs can be made.	Selected Number of Outputs: 1
Output Action	Set the write operation to perform with respect to the output memory device.	Momentary
Device to Output	Specify the output device memory address.	M20
Match Output Device with Lamp Device	Select this checkbox to set the same device memory for the output device memory and lamp device memory.	Selected

3. Select a switch and copy and paste.
4. Set as shown below.

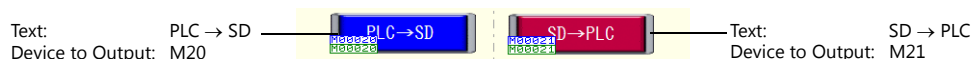

This completes the necessary settings.

Placing Text and a Switch for Returning to the Menu Screen

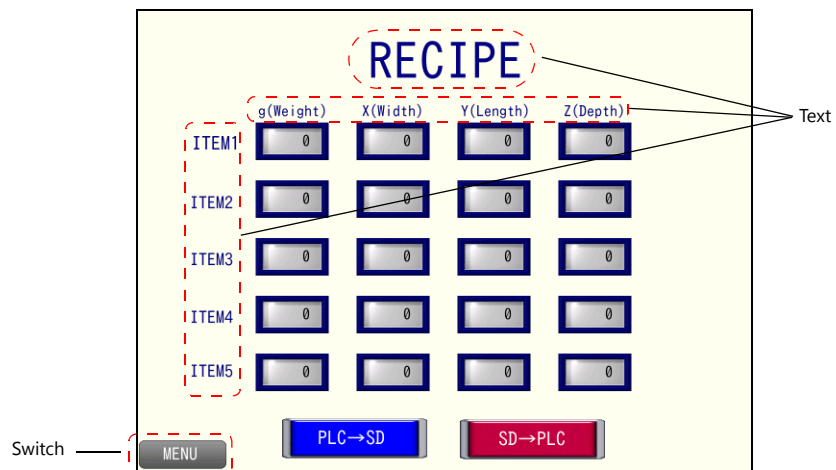

Text

Create each text part of the screen.

1. Click [Home] → [Text] → [Text]. The mouse cursor changes to a crosshair.
2. Click on the screen. A text frame is displayed.
3. Enter text.
4. Click a location on the screen other than the text.
5. Click the text to display its item view window. Adjust the text color and size.

Switch

Create a switch for returning to the menu screen.

1. Click [Home] → [Switch] and place a switch on the screen.
2. Display the switch's settings window and set [Function] to "Screen Change-over" and [Switch to No] to "0".

This completes the screen creation process.

The next section covers screen operation after transferring a screen program to the V9 series unit.

4.4 Checking Unit Operation

4.4.1 List of Used Device Memory Addresses

Device Memory	Description	Remarks
D400 to D419	Numerical data display parts	Keypad display enabled
M20	Switch: Output device memory (momentary), lamp device memory	
M21	Switch: Output device memory (momentary), lamp device memory	

4.4.2 Unit Operation

Insert the storage device into the V9 series unit.

SD → PLC Transfer

Press the [SD → PLC] switch (turn ON M21).

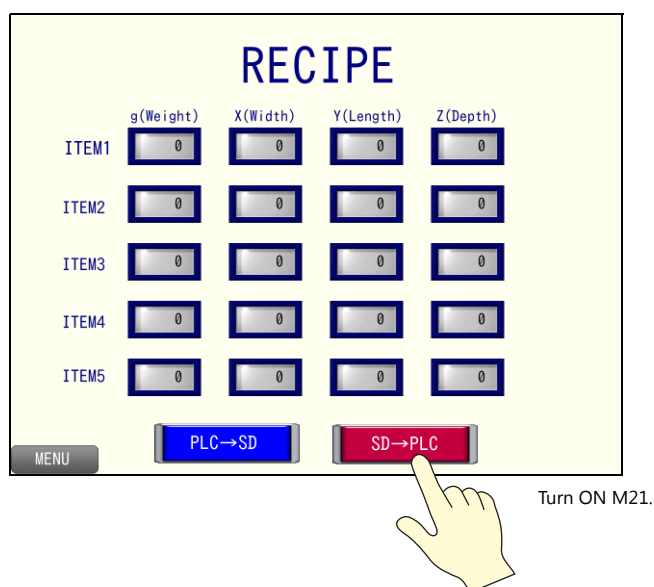

The "PRODUCT1.bin" file data is transferred to addresses D400 to D419.

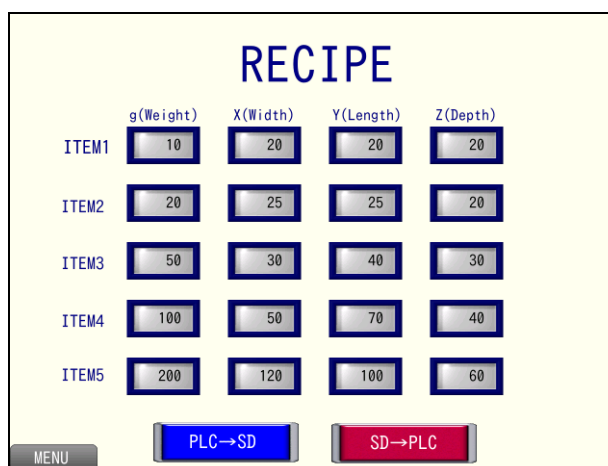

PLC → SD Transfer

1. Press the data displays of [ITEM2] and change the values using the system keypad in order.

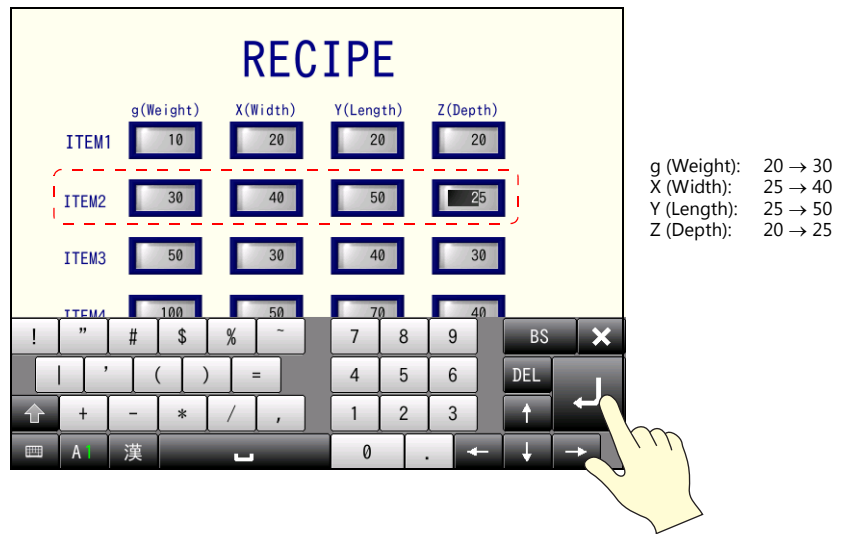

2. Press the [PLC → SD] switch (turn ON M20).

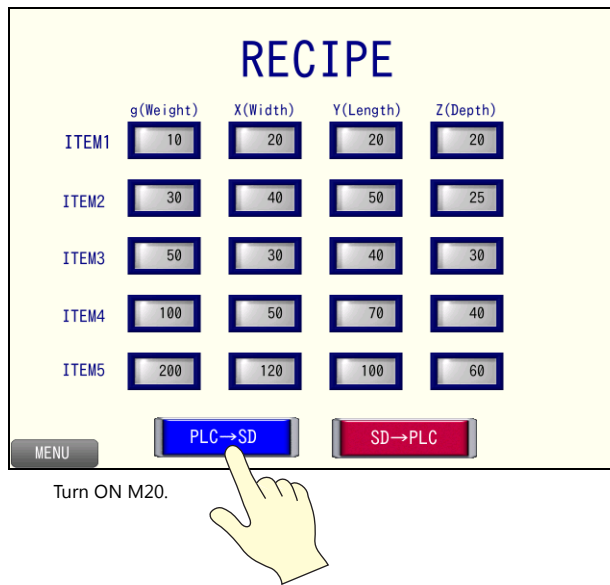

3. Press the [SYSTEM] function switch and press [Storage Removal] on the displayed system menu.

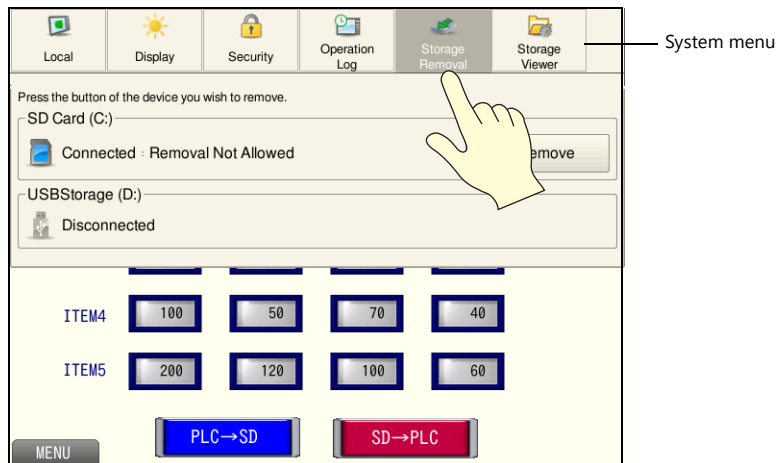

4. Press [Remove] for the device to remove. Once processing is finished, "Removal Allowed" is displayed.

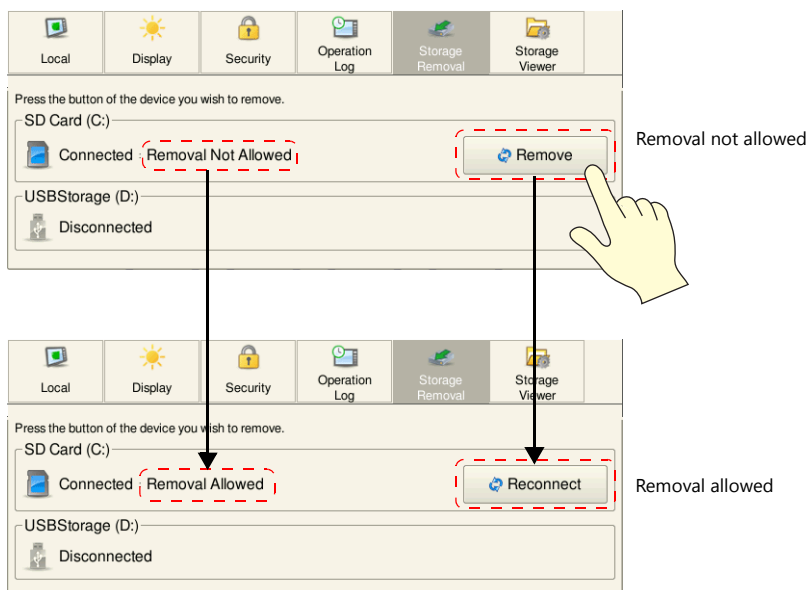

5. Remove the storage device from the V9 series unit and insert it into the PC. The storage viewer displays "Disconnected".

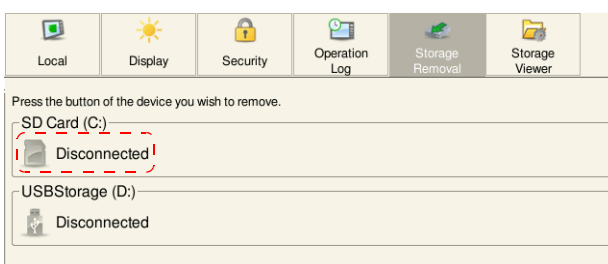

6. Open the screen program created in "4.3 Screen Creation" in the V-SFT editor.
 7. Click [System Setting] → [Recipe] and display the No. 0 recipe window.
 8. Select the storage device drive via [Recipe Data] → [Storage Drive Select].

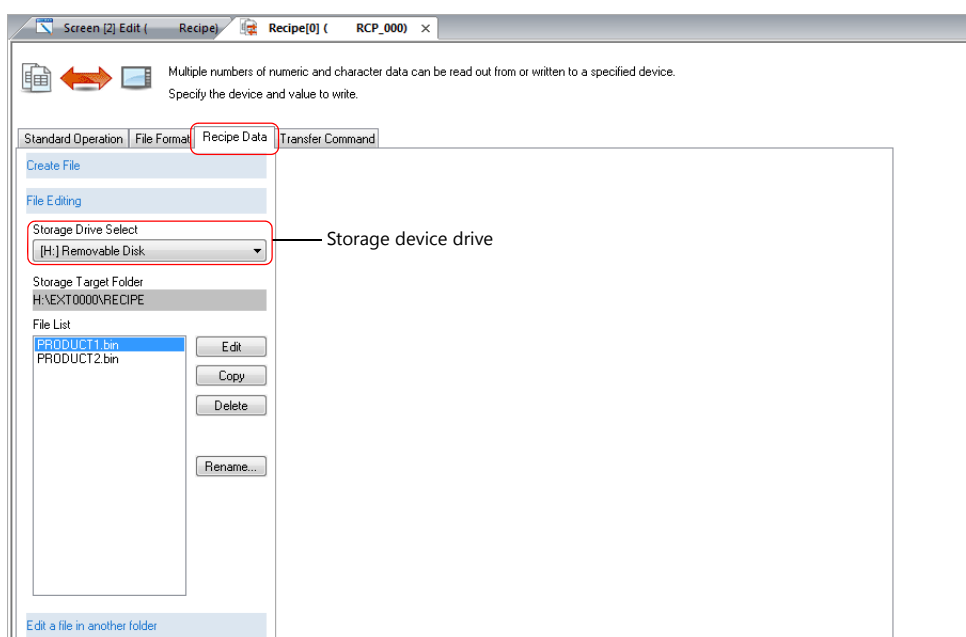

9. Select "PRODUCT1.BIN" from the file list and click [Edit].
The data of the "PRODUCT1.BIN" file is displayed.
Check that the [ITEM2] values have changed to the values specified in step 1.

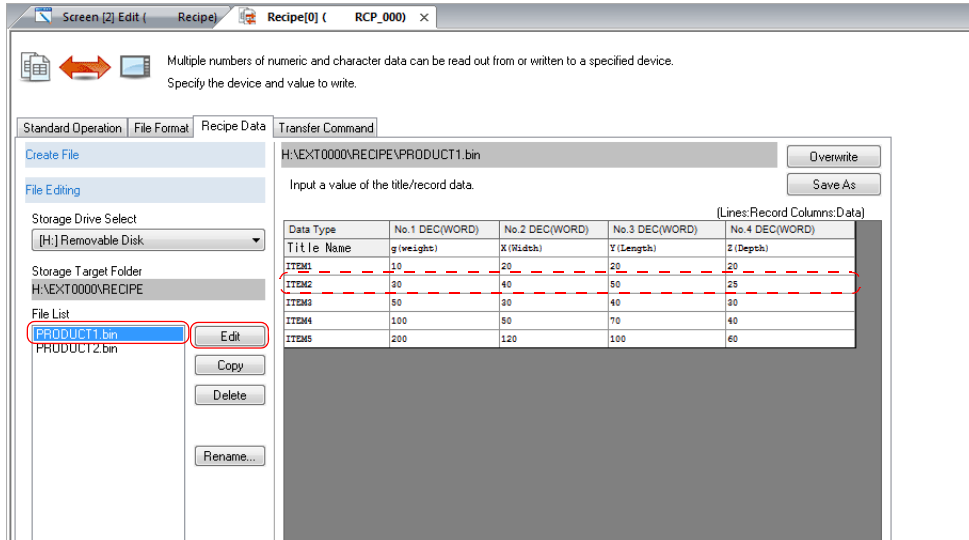

5 Scheduler

5.1 Overview

The scheduler function can execute specific operations at the specified times.

The execution time and operation are registered in the screen program in advance. Available operations include turning bit ON/OFF, data writing, and macro execution. Registered schedules can be checked in a list.

No.	Schedule Name	Trigger	Action(Start)	Action(End)	Other Settings
0	SCHEDULE_00	Every day 8:00:00	Output device Count : 1 Macro : None	None	None
1	SCHEDULE_01	Every day 0:00:00	Output device Count : 2 Macro : None	None	None
2	SCHEDULE_02	1st/Wednesday 3rd/Wednesday 17:00:00	Macro : Yes	None	None

64 maximum

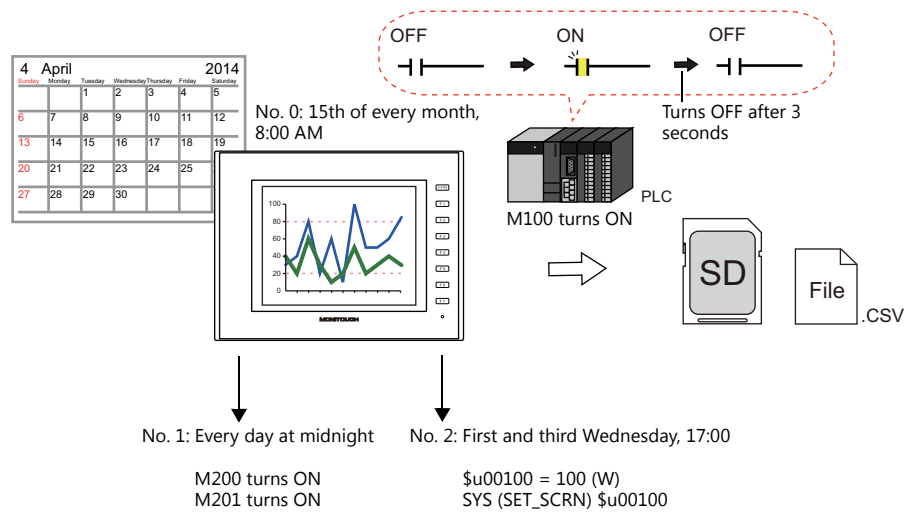

5.2 Screen Example

This chapter explains how to create a scheduler that turns ON the M100 storage output bit set in "Chapter 3 Trend Parts" on the 15th of every month at 8:00 AM. A screen for changing the clock to check the operation of the scheduler will also be created.

Screen 3

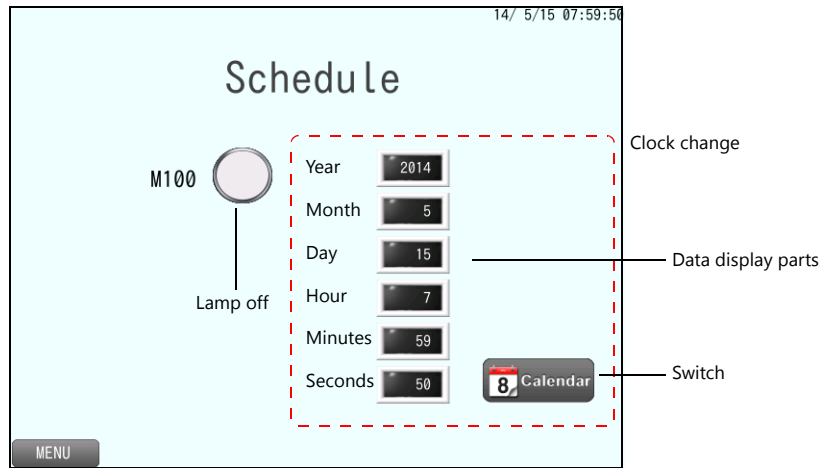

Schedule executed on the 15th at 08:00

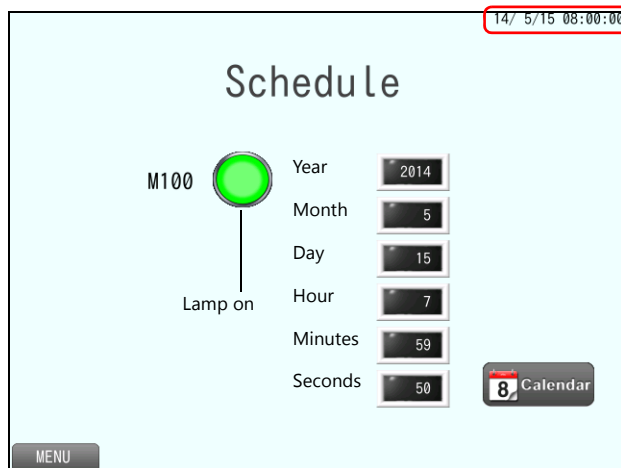

CSV file is output to the storage device.

5.3 Screen Creation

5.3.1 Scheduler Settings

Configure both the trigger (schedule time) and action (details of operation) settings.

1. Click [System Setting] → [Scheduler] to display the scheduler window.

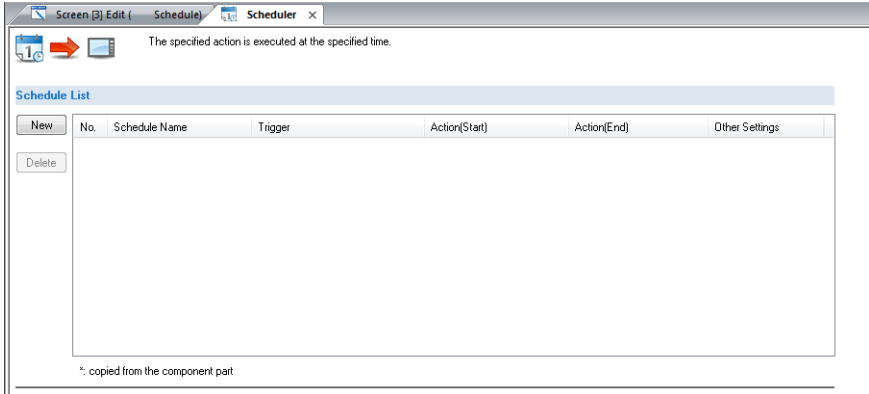

2. Click [New].
3. Configure settings on the following tabs in order.

- [General] tab



Item	Description	Setting Value
Schedule Name	Register the schedule name. 256 characters maximum	SCHEDULE_00 (default)

- [Trigger] tab (schedule time)

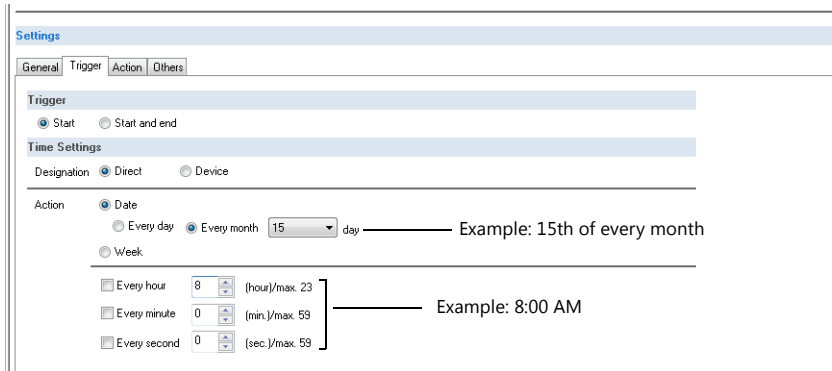

Item	Description	Setting Value
Trigger	Start Perform operation once at the start time.	Start
	Start and end Perform the start operation at the start time and the end operation at the end time.	
Designation	Direct Set a specific date and time.	Direct
	Device Set the entire date and time using device memory addresses.	
Action	Set the date and time to schedule an operation.	Date 15th of every month 8 (hour), 0 (min.), 0 (sec.)

- [Action] tab (details of operation)

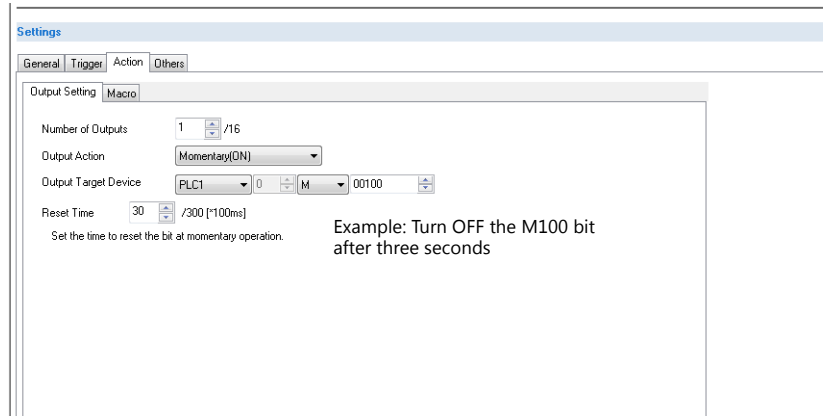

Item	Description	Setting Value
Number of Outputs	Set the number of bits to output. 1 to 16	1
Output Action	Perform bit output or word writing. Momentary (ON) Momentary (OFF) Set Reset Alternate Writing in Words	Momentary (ON)
Output Target Device	Specify the output device memory address.	M100
Reset Time	Specify when momentary is selected for [Output Action]. Set the time to wait before resetting the bit after the bit is turned ON or OFF.	30 (3 seconds)

- Others
Acknowledgment bit and interlock settings for schedule execution can be configured. These settings are not used in this example.

This completes the necessary settings.

5.3.2 Screen Editing

Clock Changing Screen

Create a clock changing screen so that you can confirm schedule execution by forcing it to be performed.

V9 Internal Clock Settings

1. Click [System Setting] → [Unit Setting] → [SRAM/Clock].
2. Select the [Use SRAM Calendar] checkbox and click [OK] to close the window.

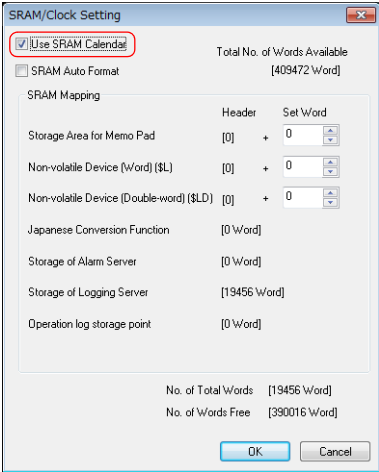

This completes the configuration of settings.

Placing a Numerical Data Display Part

1. Click [Home] → [Data Display] → [Num. Display] and place a numerical data display part on the screen.
2. Display the numerical data display's settings window and configure the following settings.
 - Contents

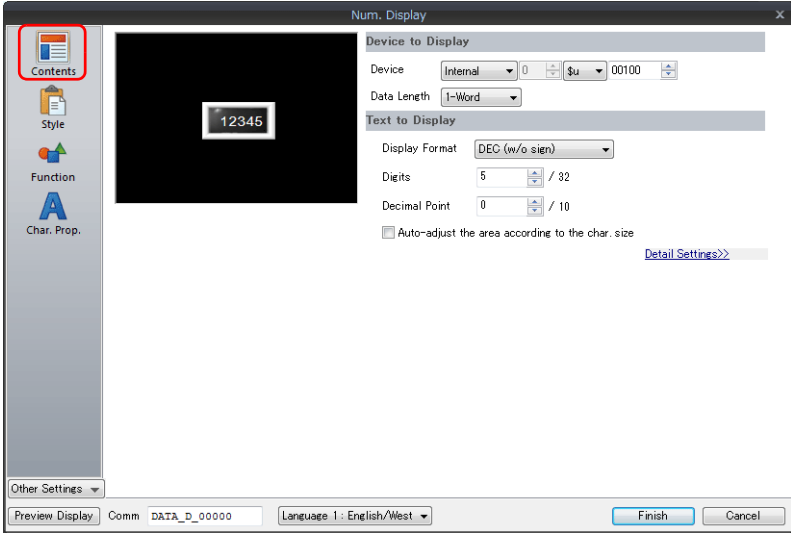

Item	Description	Setting Value
Device to Display	Set the device memory address for writing.	\$u100
Data Length	Set the attributes of the numerical data display.	1-Word
Display Format		DEC (w/o sign)
Digits		5
Decimal Point		0

- Function

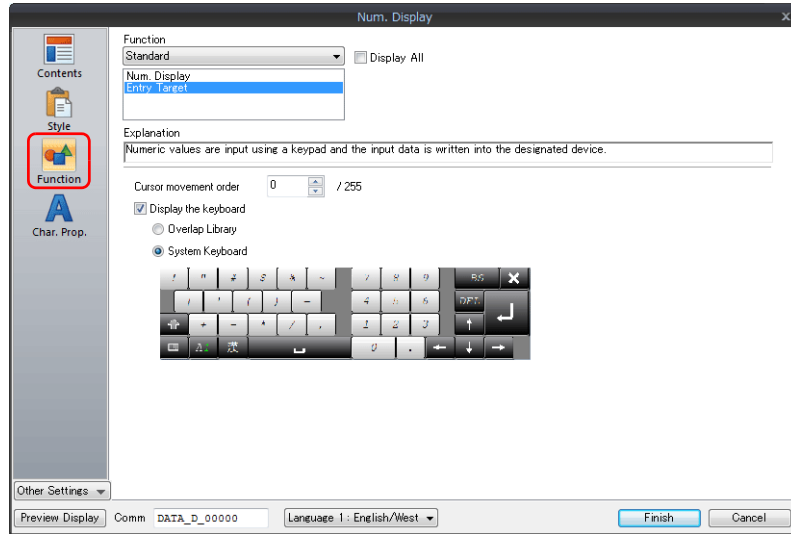

Item	Description	Setting Value
Function	Set the function to use.	Standard: Entry Target
Cursor movement order	Available when "Standard" and "Entry Target" are selected. The keypad calling function is added.	0
Display the keyboard	Display a keypad when the numerical data display is pressed.	Selected System Keyboard

3. Click [Finish] to close the window.
4. Select the numerical data display part and click [Edit] → [Multi-copy]. The [Multi Copy] window is displayed.
5. Configure the following settings and click [OK].

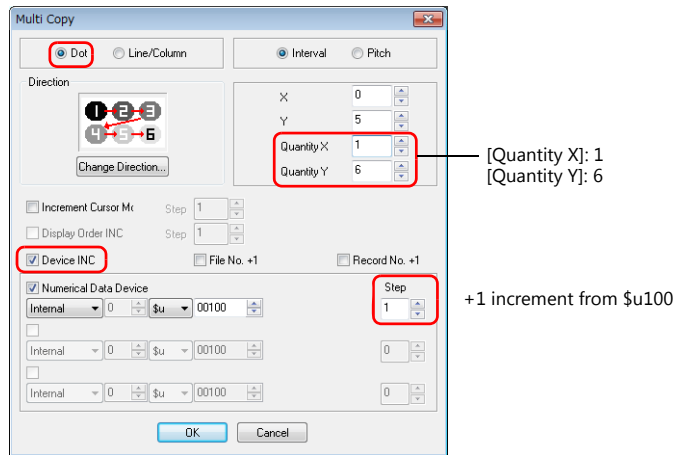

6. This makes six copies of the numerical data display part.
 Select the [View] → [Display Environment] group → [Device] checkbox to display the device memory address at the lower left of each numerical data display.
 Check that addresses \$u100 to \$u105 are assigned.

This completes the necessary settings.

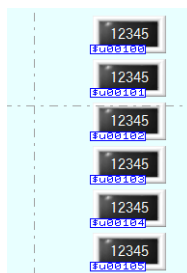

Placing a Switch (SET_SYS_CLND)

1. Click [Home] → [Switch] and place a switch on the screen.
2. To change the switch design, set it via [Style].
3. Click [Other Settings] → [Macro] → [ON Macro] → [Edit] to display the macro editor.

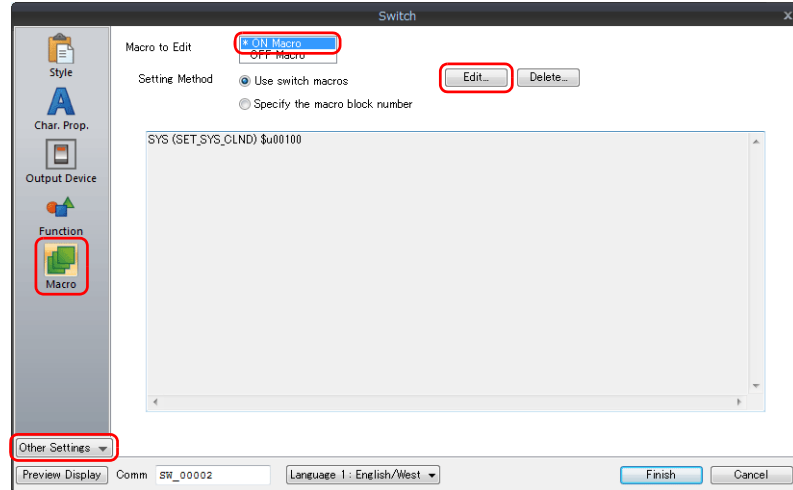

4. Click [View] → [Support Dialog] to display the [Macro Editing Support] window.

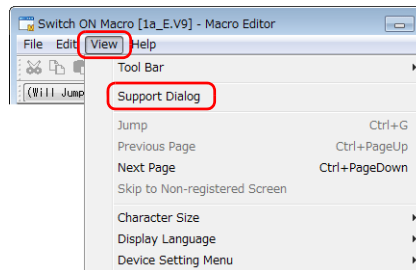

5. Configure the following settings in the [Macro Editing Support] window and click [Insert].

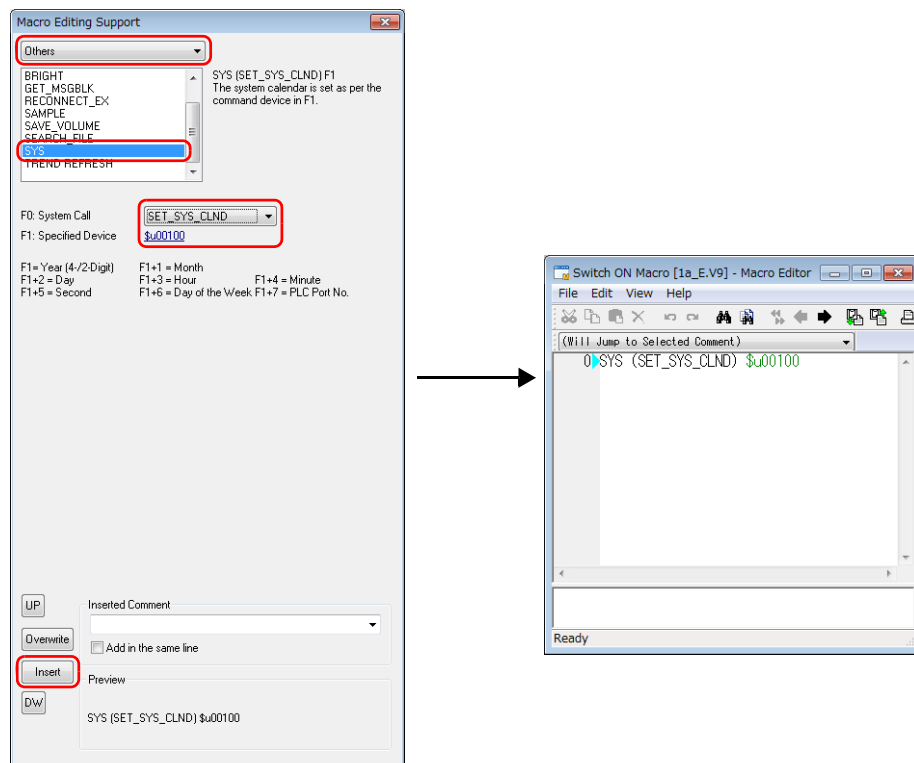

6. Close the macro editor with the [x] button.

7. Click [Finish] to close the switch settings window.

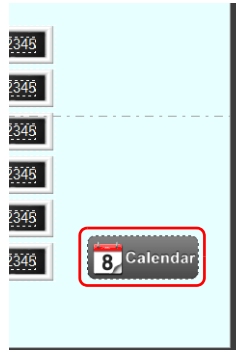

This completes the necessary settings.

Placing a Time Display Part

Click [Parts] → [Time Display] → [Time Display] and place a time display part at the upper right of the screen.



Placing Lamps

1. Click [Home] → [Lamp] and place a lamp on the screen.
2. Display the lamp's settings window and configure the following settings.
 - Style

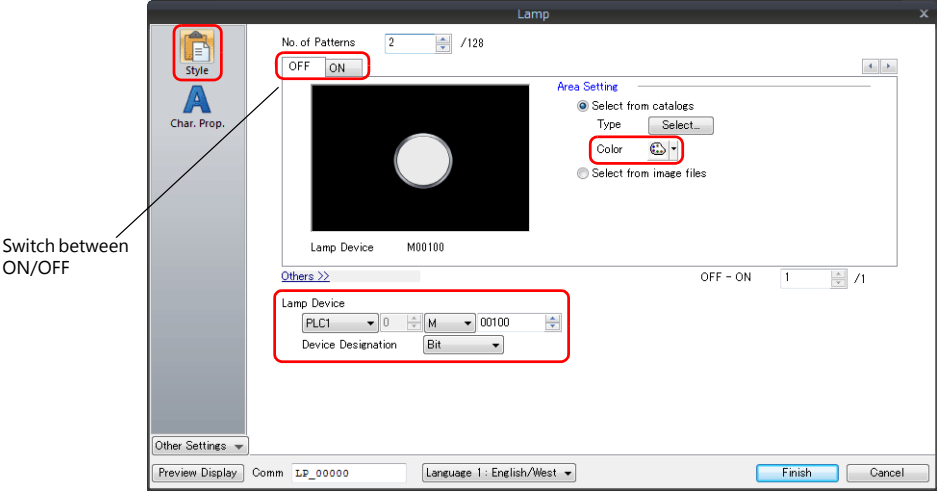

Item	Description	Setting Value
Area Setting	Set the part design.	Color OFF: White ON: Green
Lamp Device	Bit The lamp display is changed by setting (ON) and resetting (OFF) bits. Bits are assigned consecutively to added patterns.	M100 Bit
Device Designation	Word Change the lamp display by writing a word to the device memory.	

3. Click [Finish] to close the lamp settings window.

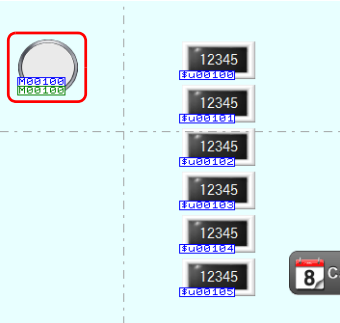

Placing Text and a Switch for Returning to the Menu Screen

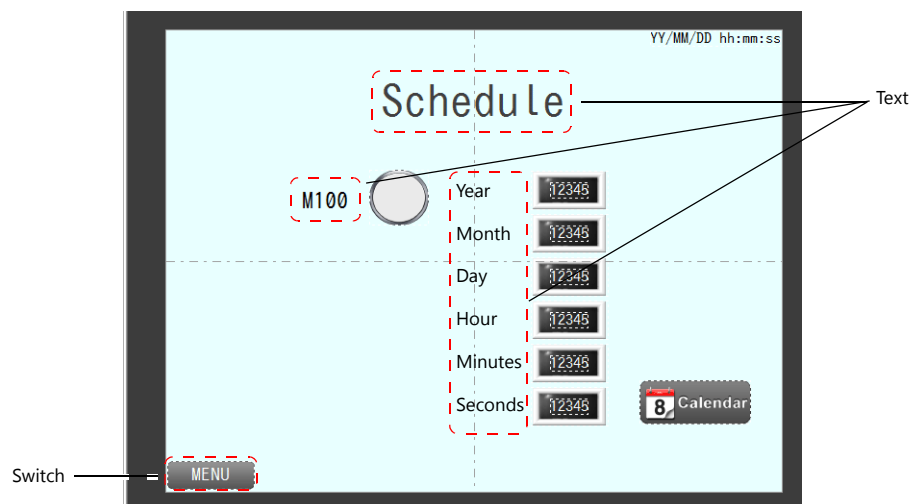

Text

Create each text part of the screen.

1. Click [Home] → [Text] → [Text]. The mouse cursor changes to a crosshair.
2. Click on the screen. A text frame is displayed.
3. Enter text.
4. Click a location on the screen other than the text.
5. Click the text to display its item view window. Adjust the text color and size.

Switch

Create a switch for returning to the menu screen.

1. Click [Home] → [Switch] and place a switch on the screen.
2. Display the switch's settings window and set [Function] to "Screen Change-over" and [Switch to No] to "0".

This completes the screen creation process.

The next section covers screen operation after transferring the screen program to the V9 series unit.

5.4 Checking Unit Operation

5.4.1 List of Used Device Memory Addresses

Device Memory	Description	Remarks
\$u100 to \$u105	Numerical data display parts	Keypad display enabled
M100	Lamp device and storage output bit of the logging server No. 0 (page 3-5)	

5.4.2 Unit Operation

Change the clock, forcibly execute the schedule, and check the operation result.

1. Tap the numerical value displays and set the values of [Year], [Month], [Day], [Hour], [Minutes], and [Seconds] in order.

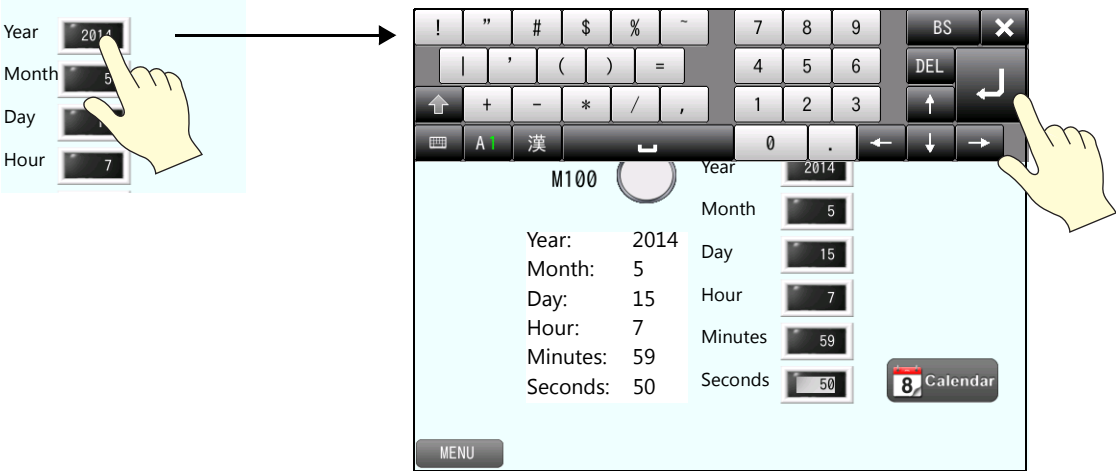

2. Press the switch. The V9 internal clock is updated and 14/5/15 07:59:50 is displayed at the upper right.

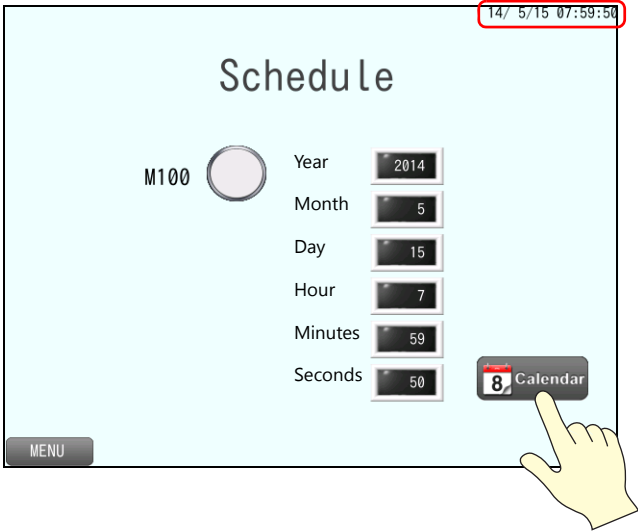

At 14/5/15 08:00:00, the lamp will change from white to green (M100 turns ON).
 After three seconds, the lamp will return from green to white (M100 turns OFF).

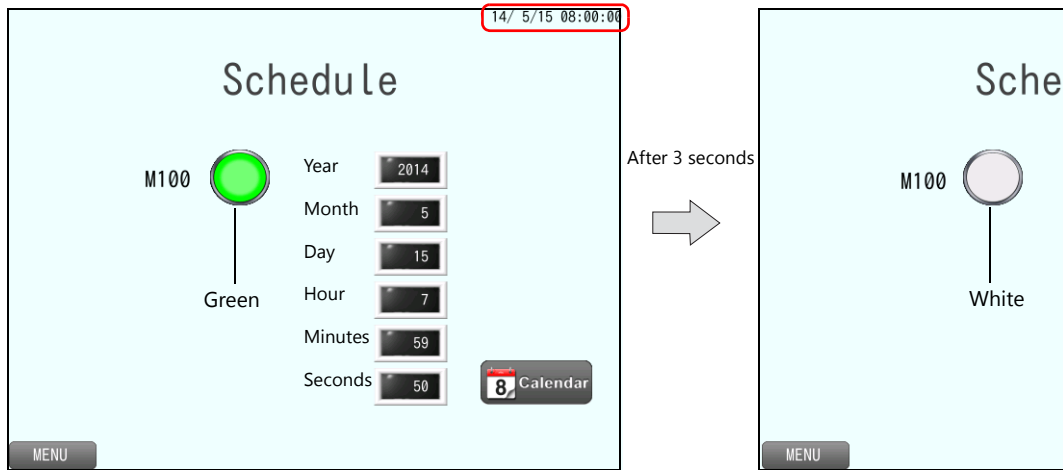

3. Press the [SYSTEM] function switch and press the [Storage Viewer] switch on the system menu.

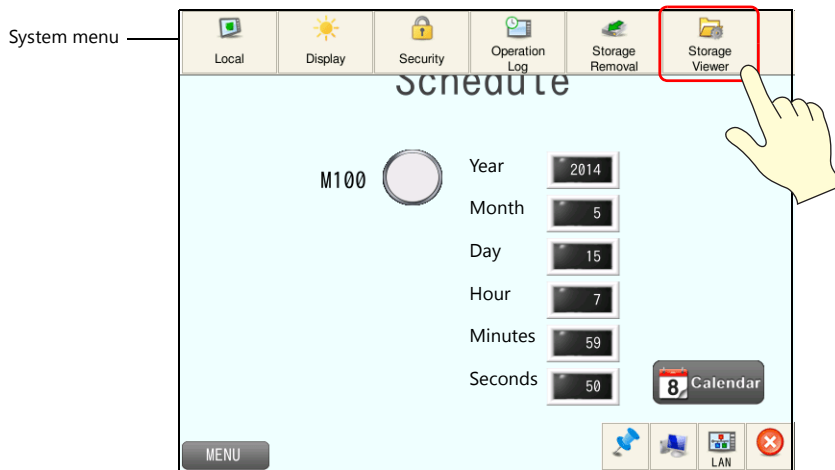

Check that CSV and backup files have been created in the LOGGING folder.

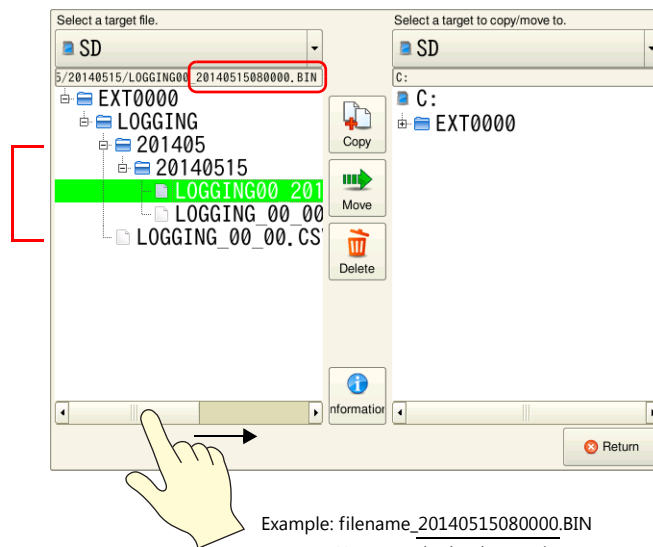

Example: filename_20140515080000.BIN
 Year, month, day, hour, minutes, seconds

6 Security

6.1 Overview

By registering user IDs and passwords at the required security levels in advance, the number of items displayed on the screen can be changed and switching of screens can be restricted according to the security level of the user. Security levels are set on a scale from 0 to 15.

Security Level	Priority	Description
0	↓ Low High	Screen display and operation permitted at level 0 (no security)
1		Screen display and operation permitted at levels 0 and 1
:		:
15		Screen display and operation permitted at all levels from 0 through 15

- Item security levels
The items for display can be changed according to level.

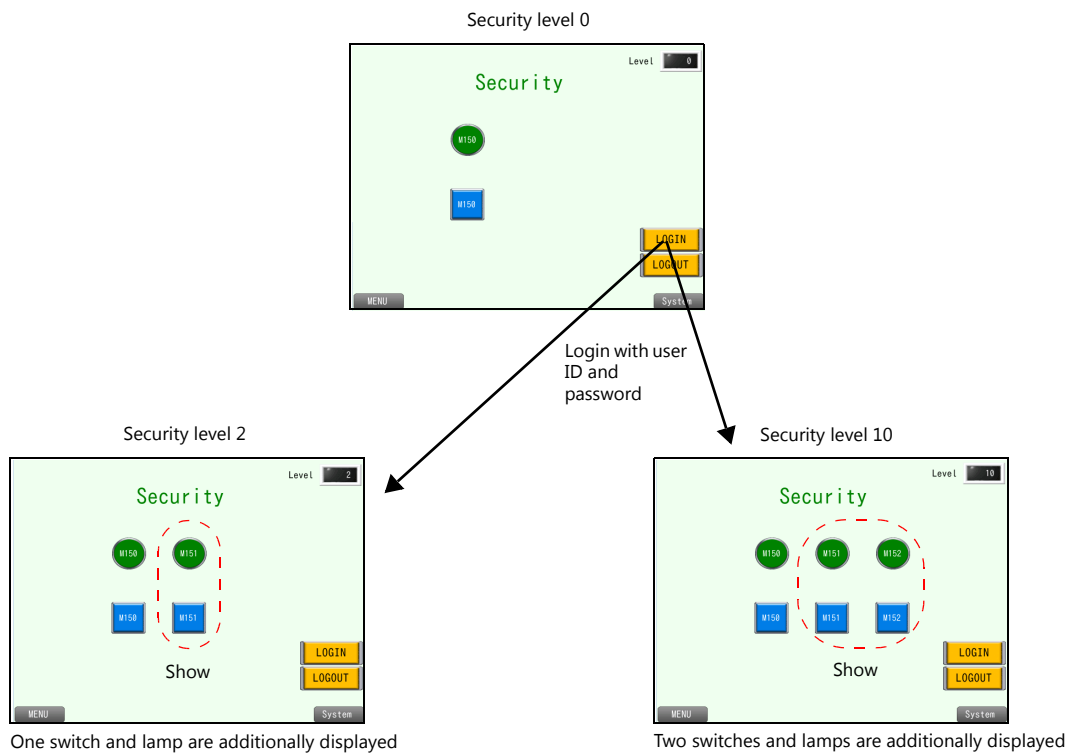

- Screen security level
Screen switching can be permitted/prohibited according to level.

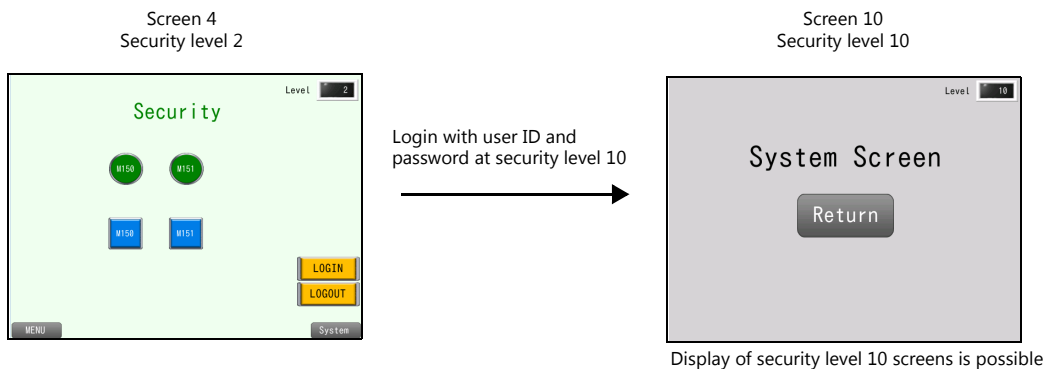

6.2 Screen Example

This chapter explains how to create a screen that operates as follows.

Screen Example 1 (Item Security Level)

Screen 4

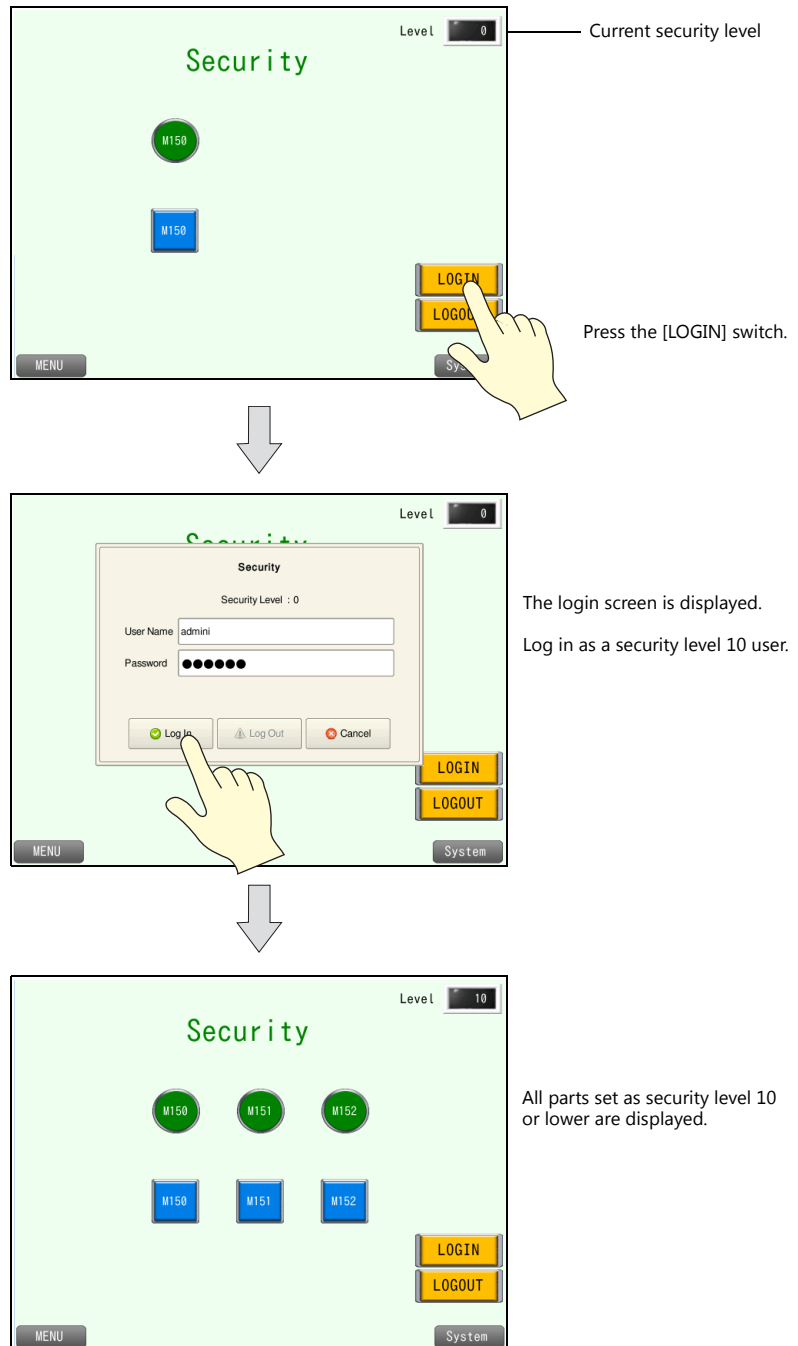

Screen Example 2 (Screen Security Level)

Screen 4

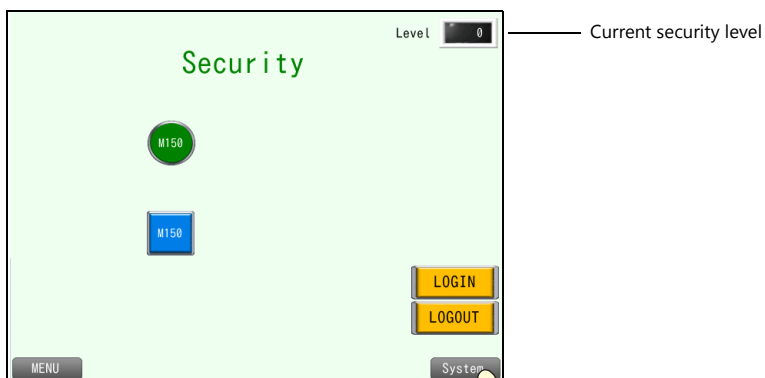

Current security level



Changeover the screen.

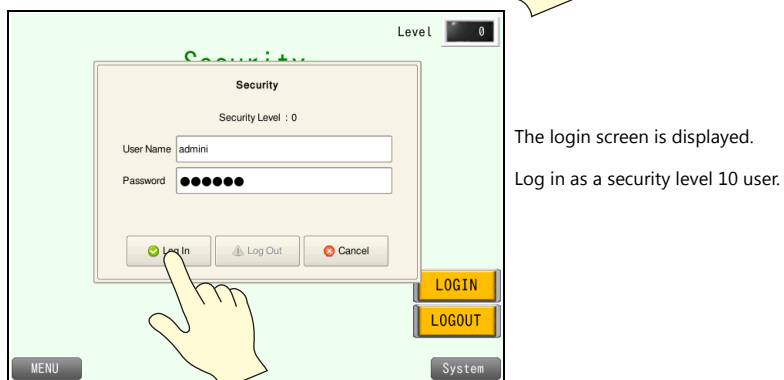

The login screen is displayed.
Log in as a security level 10 user.



Screen 10

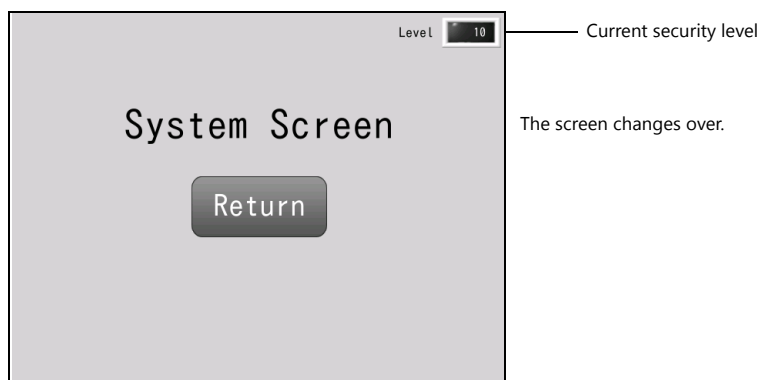

Current security level

The screen changes over.

6.3 Screen Creation

6.3.1 Security Settings

Set a user ID, password, and corresponding security level.

1. Click [System Setting] → [Other] → [Security Setting]. The [Security Setting] window is displayed.
2. Select the [Use security function] checkbox and set each item.

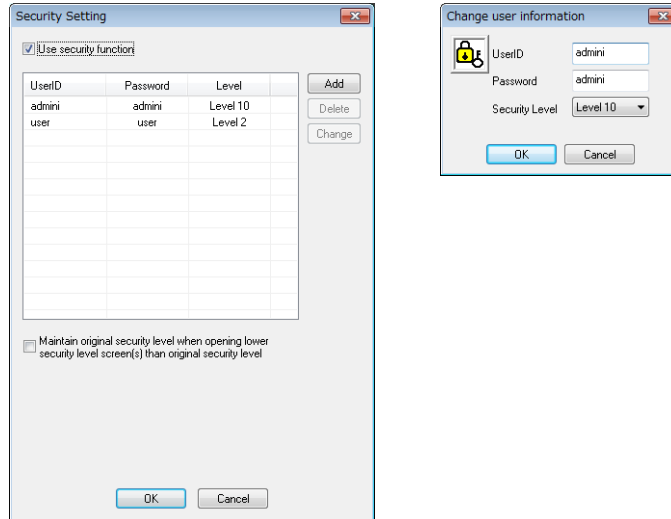

Item	Description	Setting Value
User ID Password Level	Register user IDs, passwords, and security levels using the [Add], [Delete], and [Change] buttons. Maximum of 64 entries, maximum of 8 one-byte alphanumeric characters (case sensitive) * Duplicate user IDs cannot be registered. (All users registered to the screen program are granted administrator privileges.)	First user: User ID: admini Password: admini Level: 10 Second user: User ID: user Password: user Level: 2
Maintain original security level when opening lower security level screen(s) than original security level	Select the operation to perform when a screen change occurs. Unselected When switching to a screen with a lower security level, the currently valid security level is also lowered to the level of the target screen. When switching to a higher-security screen next, the operator is prompted to enter a password. Selected The same security level is maintained until the level is changed when another user logs in with a different security level or when the user logs out.	Unselected

3. Click [OK] to close the window.

This completes the necessary settings.

6.3.2 Screen Editing (Screen Example 1)

Create a screen that changes the displayed items according to security level.

Placing Switches

1. Click [Home] → [Switch] and place a switch on the screen.
2. Display the switch's settings window and configure the following settings.
 - Char. Prop.

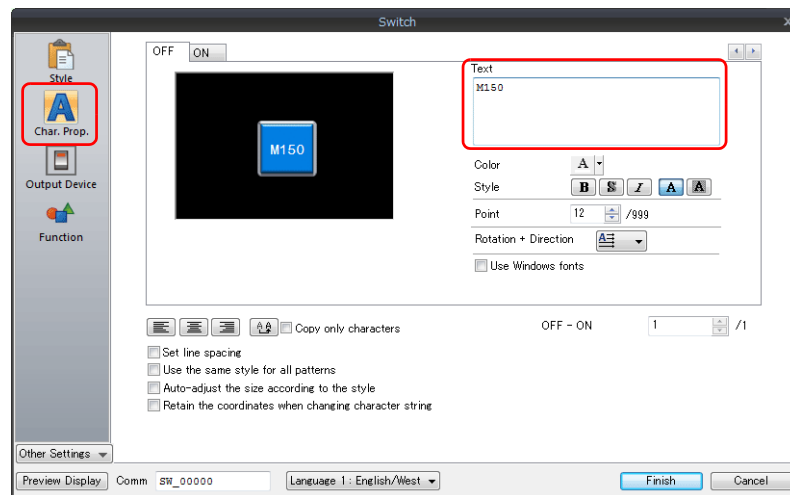

Item	Description	Setting Value
Text	Set the text to be displayed on the switch.	M150
Color Style Point Rotation + Direction Use Windows fonts	Set properties including text color, properties, and text size.	–

- Output Device

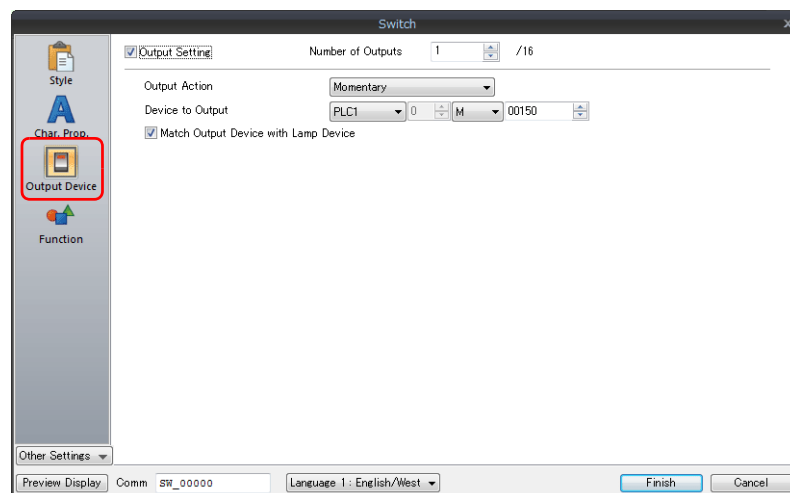

Item	Description	Setting Value
Output Setting	Data is output to device memory when the switch is pressed. A maximum of 16 outputs can be made.	Selected Number of Outputs: 1
Output Action	Set the write operation to perform with respect to the output memory device.	Momentary
Device to Output	Specify the output device memory address.	M150
Match Output Device with Lamp Device	Select this checkbox to set the same device memory for the output device memory and lamp device memory.	Selected

- Show/Hide (display method: [Other Settings] → [Show/Hide])

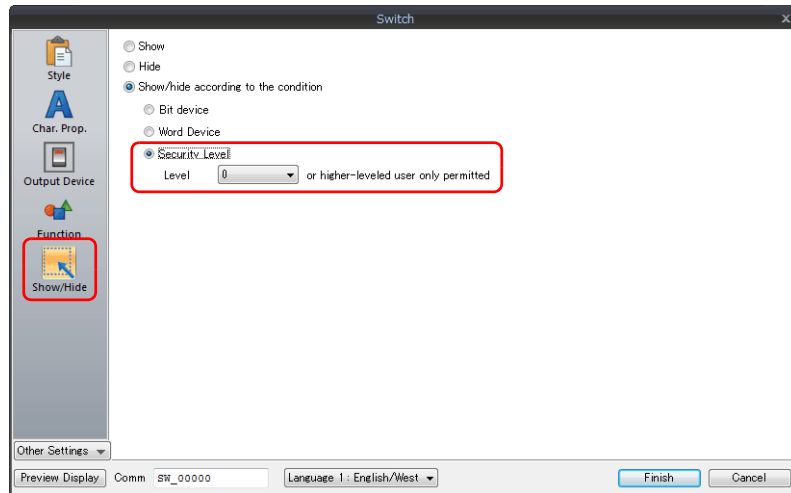

Item	Description	Setting Value
Show/Hide	Control the display state for RUN mode.	Show/hide according to the condition Security level 0

3. Click the [Finish] button.
4. Select the switch and click [Edit] → [Multi-copy]. The [Multi Copy] window is displayed.
5. Configure the following settings and click [OK].

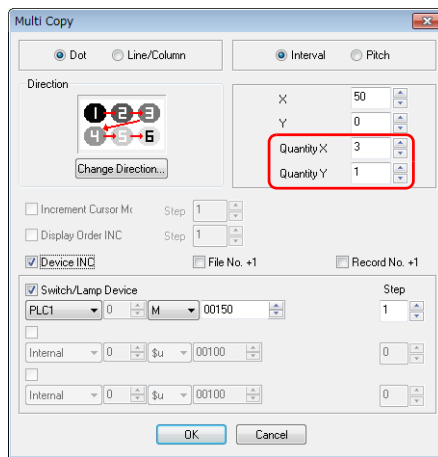

[Quantity X]: 3
[Quantity Y]: 1

6. Three copies of the switch are made.
Select the [View] → [Display Environment] group → [Device] checkbox to display the device memory address at the lower left of each switch.
7. Change the text and security level in the same manner for the remaining two switches.

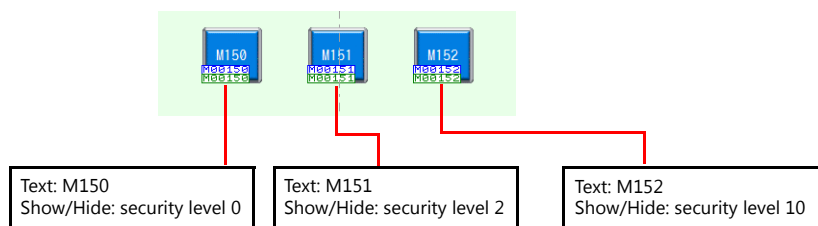

This completes the switch creation process.

Placing Lamps

1. Click [Home] → [Lamp] and place a lamp on the screen.
2. Display the lamp's settings window and configure the following settings.
 - Style

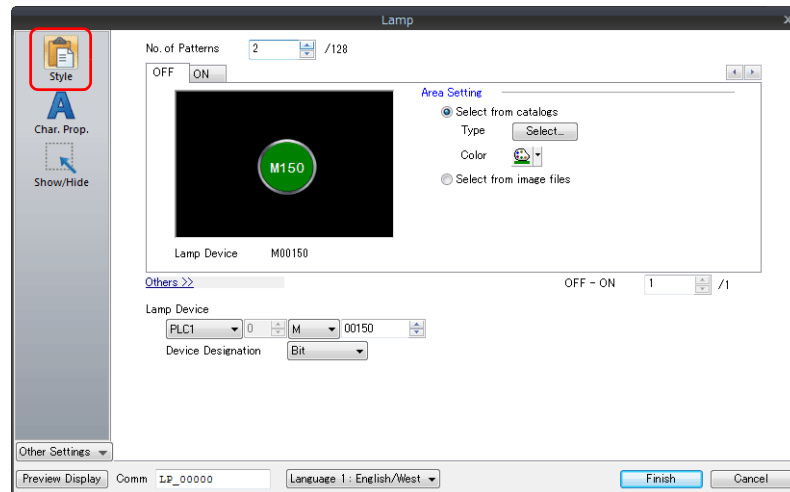

Item	Description	Setting Value
No. of Patterns	Set the number of patterns that the lamp can display. Maximum of 128	2
Lamp Device	Set the write operation to perform with respect to the output memory device.	M150 Bit

- Char. Prop.

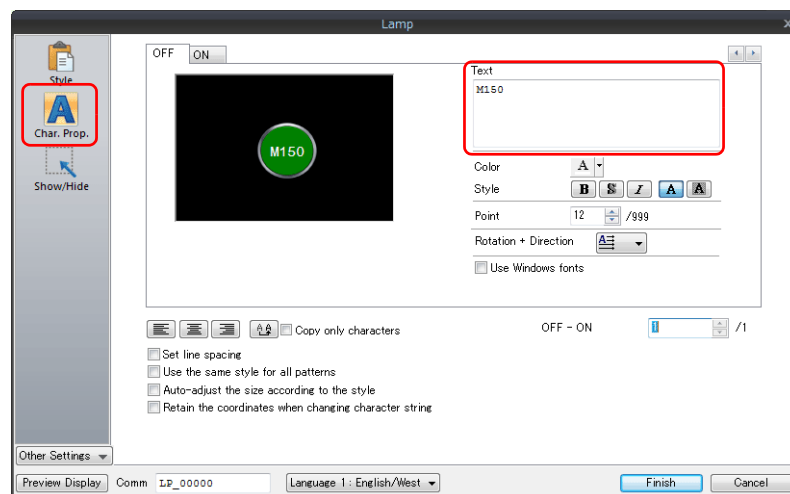

Item	Description	Setting Value
Text	Set the text to be displayed on the lamp.	M150
Color Style Point Rotation + Direction Use Windows fonts	Set properties including text color, properties, and text size.	–

- Show/Hide (display method: [Other Settings] → [Show/Hide])

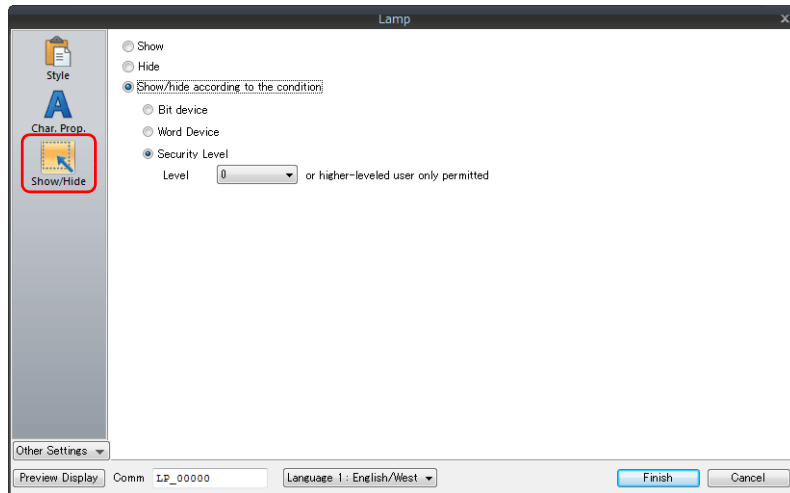

Item	Description	Setting Value
Show/Hide	Control the display state for RUN mode.	Show/hide according to the condition Security level 0

3. Click the [Finish] button.
4. Select the lamp and click [Edit] → [Multi-copy]. The [Multi Copy] window is displayed.
5. Configure the following settings and click [OK].

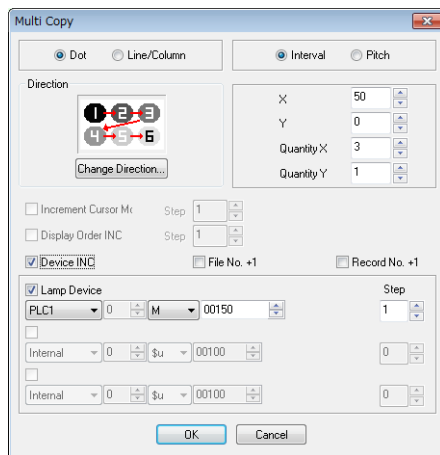

[Quantity X]: 3

6. Copies of the lamp are made.
Select the [View] → [Display Environment] group → [Device] checkbox to display the device memory address at the lower left of each lamp.
7. Change the text and security level in the same manner for the remaining two lamps.

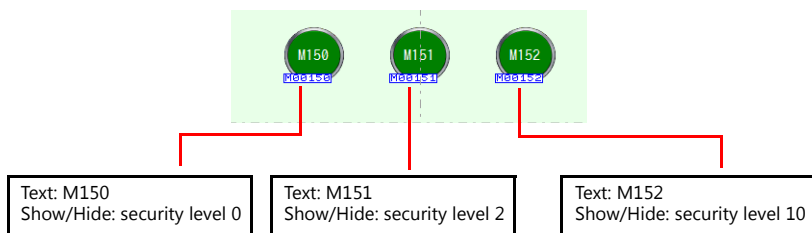

This completes the lamp creation process.

Placing Login/Logout Switches

1. Click [Home] → [Switch] and place a switch on the screen.
2. Display the switch's settings window and configure the following settings.
 - Char. Prop.

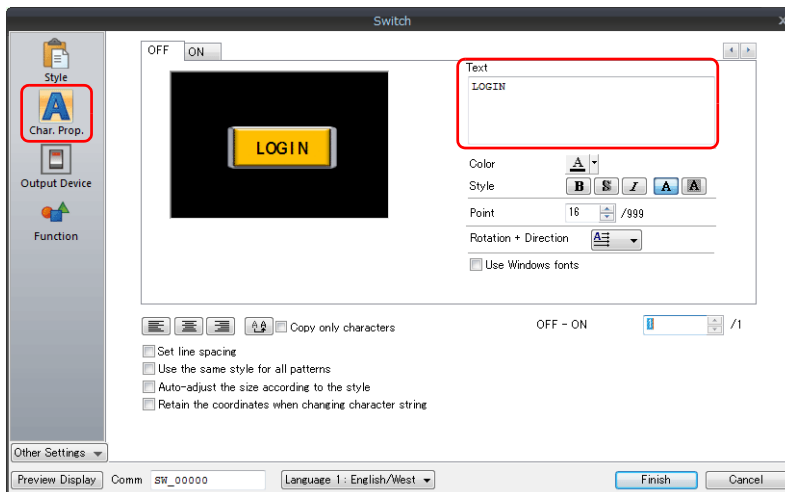

Item	Description	Setting Value
Text	Set the text to be displayed on the switch.	LOGIN
Color Style Point Rotation + Direction Use Windows fonts	Set properties including text color, properties, and text size.	-

- Function

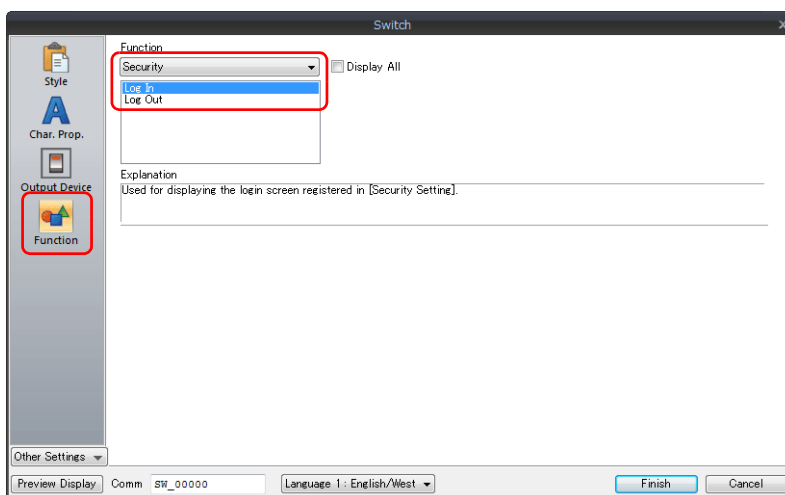

Item	Description	Setting Value
Function	Set the operation to perform when the switch is pressed.	Security Log In
	Log In Display the login screen.	
	Log Out Change the security level to 0.	

3. Click the [Finish] button.
4. Select the [LOGIN] switch and copy and paste.

- Change the text and function of the copied switch.

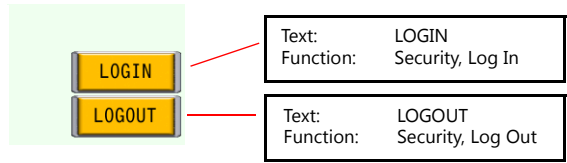

This completes the switch creation process.

Placing a Numerical Value Display Part (For Checking the Current Security Level)

Create a numerical value display for checking the security level when logged in.

- Click [Home] → [Data Display] → [Num. Display] and place a numerical data display part on the screen.
- Display the numerical data display's settings window and configure the following settings.
 - Contents

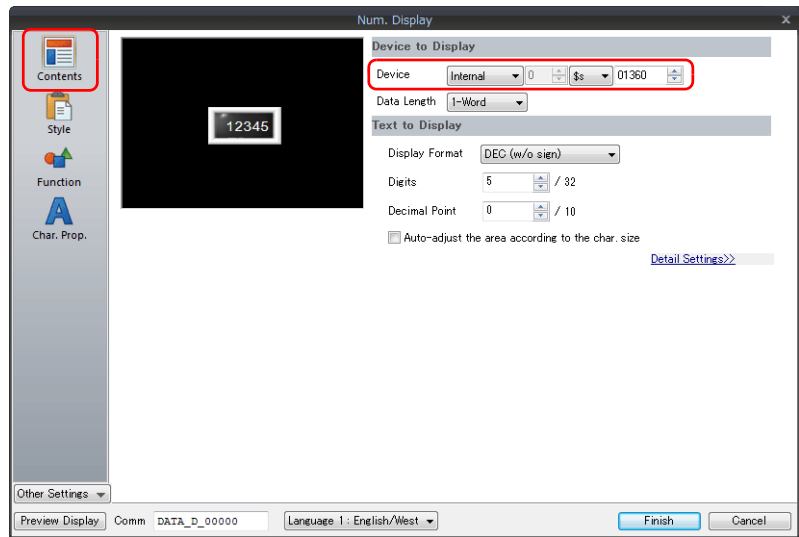

Item	Description	Setting Value
Device to Display	Specify the device memory address to monitor.	Internal \$s1360

Click the [Complete] button.

Placing Text and a Switch for Returning to the Menu Screen

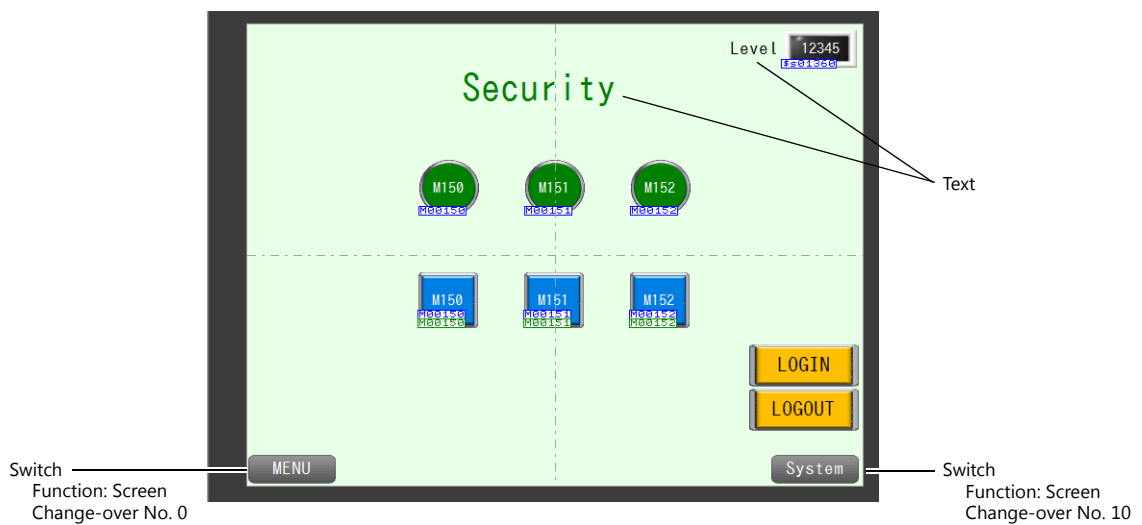

Text

Create each text part of the screen.

1. Click [Home] → [Text] → [Text]. The mouse cursor changes to a crosshair.
2. Click on the screen. A text frame is displayed.
3. Enter text.
4. Click a location on the screen other than the text.
5. Click the text to display its item view window. Adjust the text color and size.

Switch

Create a switch for returning to the menu screen (screen No. 0) and changing over to screen No. 10 (for screen example 2).

1. Click [Home] → [Switch] and place a switch on the screen.
2. Display the switch's settings window and set [Function] to "Screen Change-over" and [Switch to No] to "0".
3. Copy and paste the switch.
Set [Function] to "Screen Change-over" and [Switch to No] to "10".

This completes the screen creation process.

Proceed to ["6.3.3 Screen Editing \(Screen Example 2\)"](#). To check screen example 1 only, transfer the screen program to the V9 series unit and check that it works.

6.3.3 Screen Editing (Screen Example 2)

Create a screen for controlling the permitting or prohibiting of screen changeover by using security levels.

Screen Settings (Screen No. 10)

1. Display screen No. 10. Click [Screen Setting] → [Screen Setting].
2. Set a value for [Security Level] on the [Main] tab window.

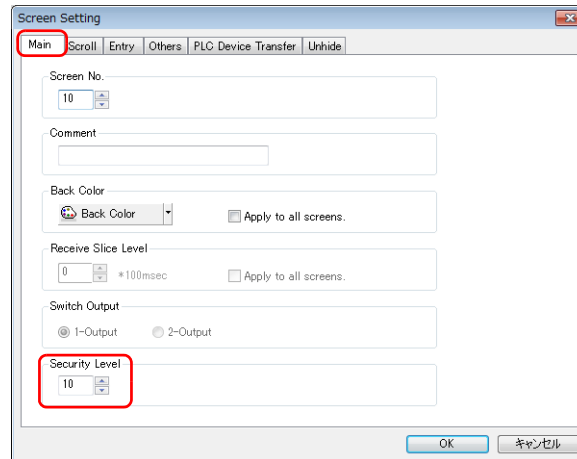

Item	Description	Setting Value
Security Level	Specify the security level of the screen.	10

3. Click [OK].

Placing a Numerical Value Display Part (For Checking the Current Security Level)

Create a numerical value display for checking the security level when logged in.

1. Click [Home] → [Data Display] → [Num. Display] and place a numerical data display part on the screen.
2. Display the numerical data display's settings window and configure the following settings.
 - Contents

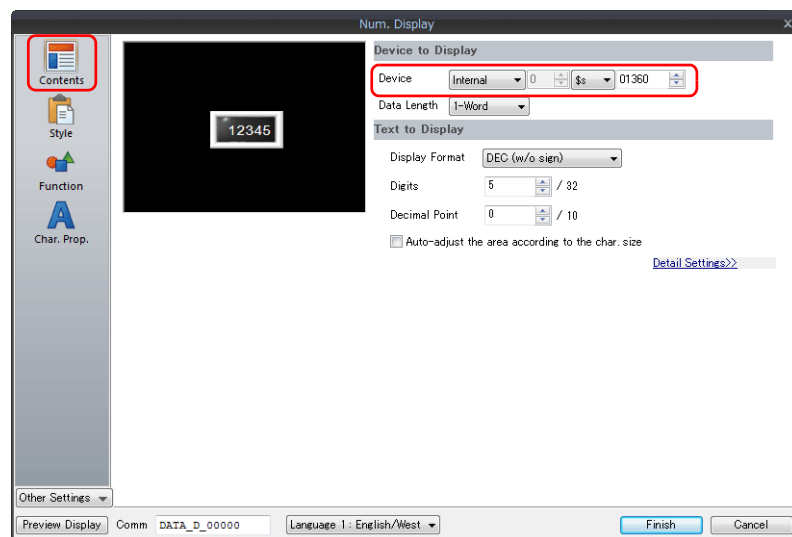

Item	Description	Setting Value
Device to Display	Specify the device memory address to monitor.	Internal \$s1360

3. Click the [Finish] button.

Placing Text and a Switch for Returning to the Menu Screen

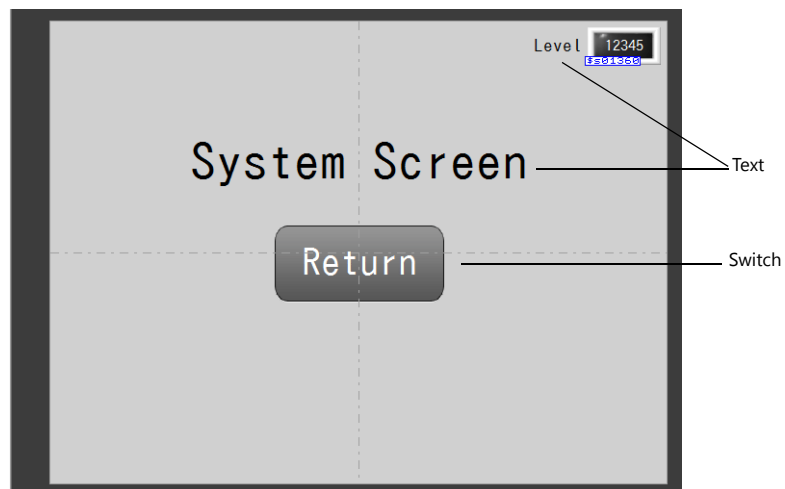

Text

Create each text part of the screen.

1. Click [Home] → [Text] → [Text]. The mouse cursor changes to a crosshair.
2. Click on the screen. A text frame is displayed.
3. Enter text.
4. Click a location on the screen other than the text.
5. Click the text to display its item view window. Adjust the text color and size.

Switch

Create a switch for returning to the security screen (screen No. 4).

1. Click [Home] → [Switch] and place a switch on the screen.
2. Display the switch's settings window and set [Function] to "Screen Change-over" and [Switch to No] to "4".

This completes the screen creation process.

The next section covers screen operation after transferring the screen program to the V9 series unit.

6.4 Checking Unit Operation

6.4.1 List of Used Device Memory Addresses

Device Memory	Description	Remarks
M150	Switch: Output device memory, lamp device memory Lamp: Lamp device memory	
M151	Switch: Output device memory, lamp device memory Lamp: Lamp device memory	
M152	Switch: Output device memory, lamp device memory Lamp: Lamp device memory	

6.4.2 Unit Operation

Item Security Level (Screen Example 1)

1. Press the [LOGIN] switch.

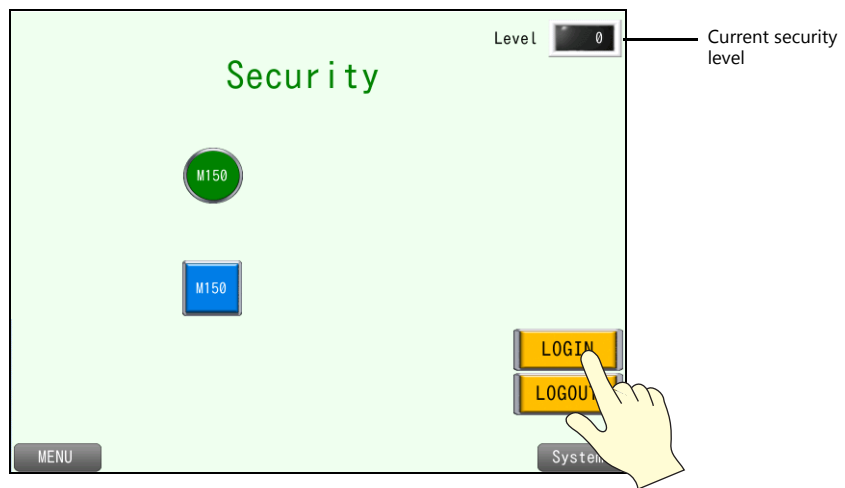

2. The login screen is displayed.
Enter "user" for the user name and "user" for the password and press [Log In].

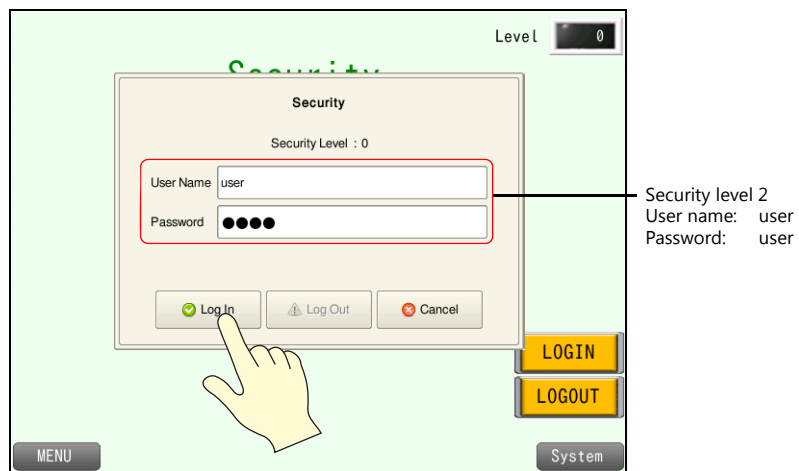

3. The security level changes to 2.
Items set as security level 2 or lower are displayed. Press the [LOGIN] switch again.

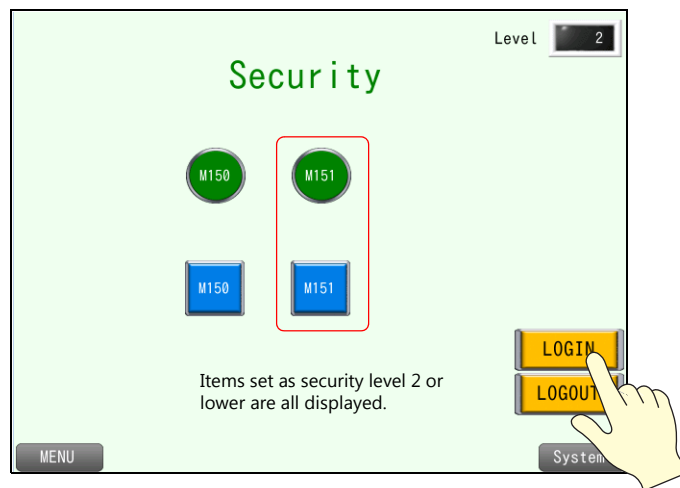

4. The login screen is displayed.
Enter "admini" for the user name and "admini" for the password and press [Log In].

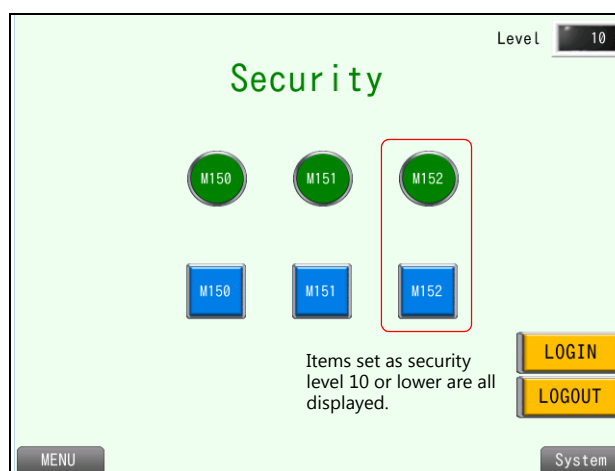
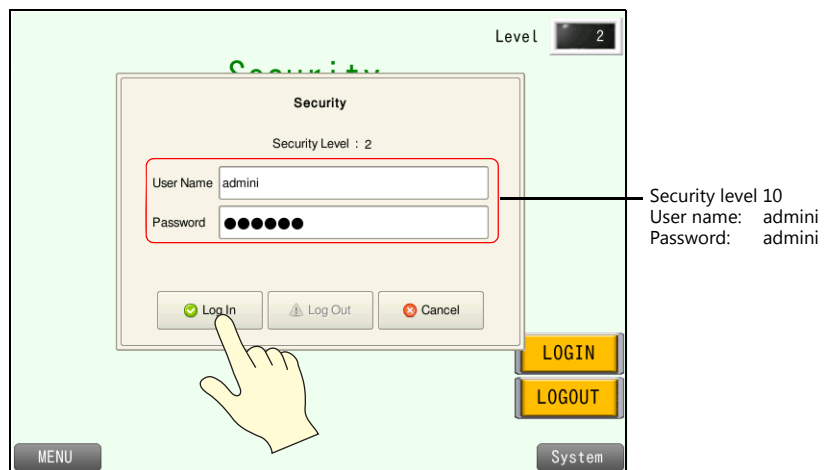

5. Press the [LOGOUT] switch.

The security level returns to 0. Items set as security level 1 or higher are all hidden.

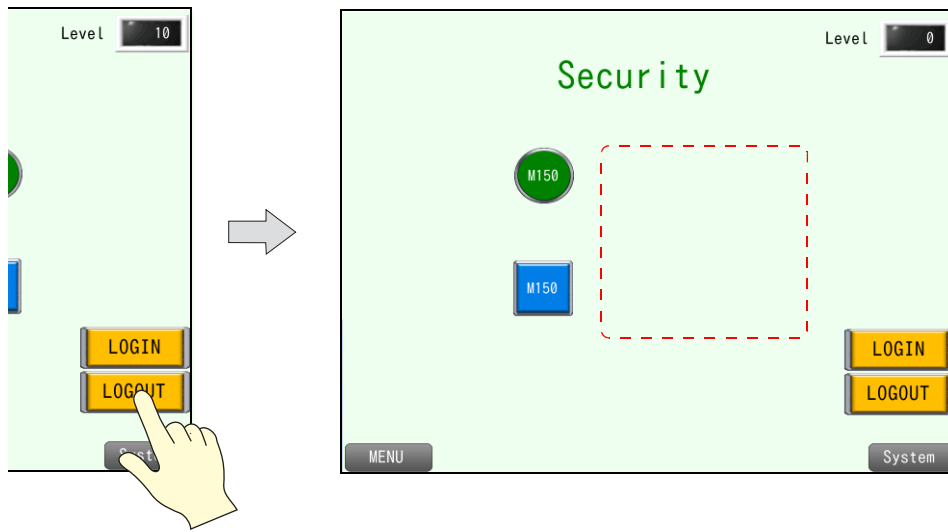

Screen Security Level (Screen Example 2)

1. Press the screen changeover switch.

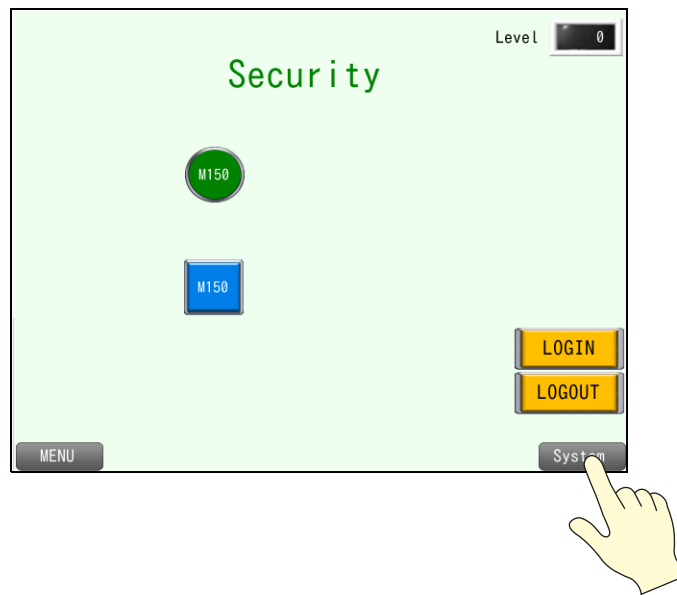

2. Enter "admini" for the user name and "admini" for the password and press [Log In].

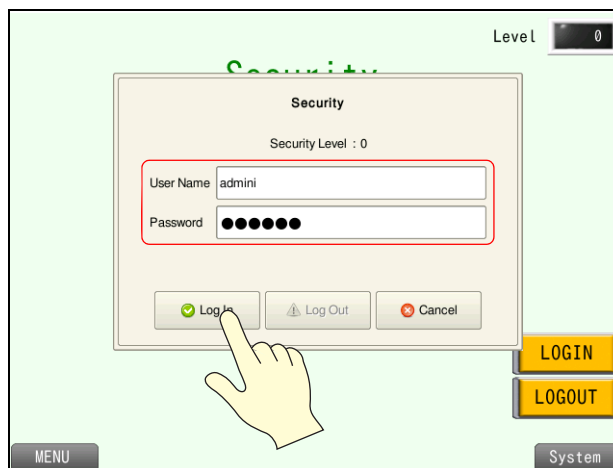

The security level changes to 10 and the screen changes over.

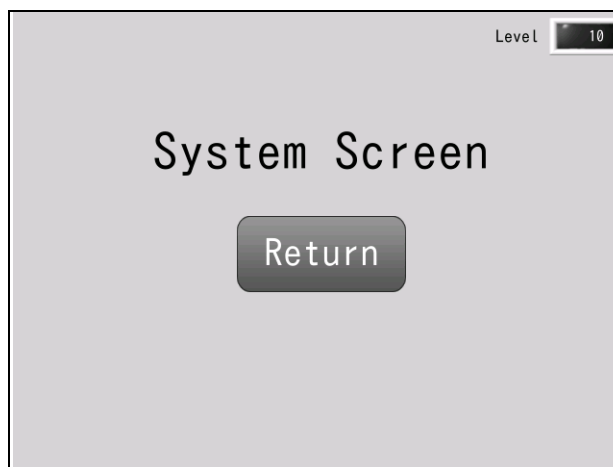

Registering Additional User IDs and Passwords

In addition to registering to screen programs, user IDs and passwords can be newly registered via the system menu (or Local mode).

Only users with administrator privileges can newly register, edit, and delete user accounts.

1. Switch to Local mode.
2. Press [Administrator Authentication] on the [User Settings] menu.

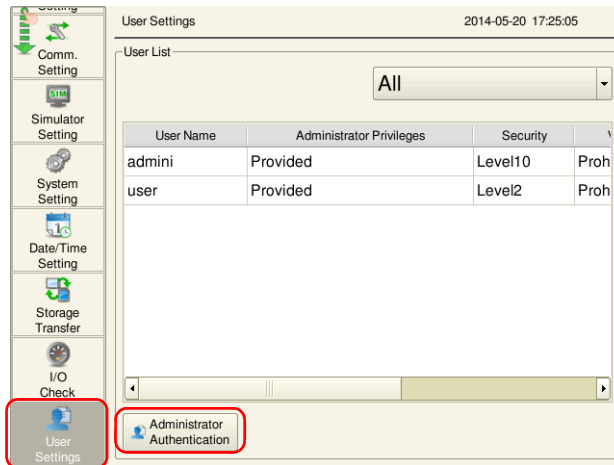

3. Input an [Administrator Name] and [Password].

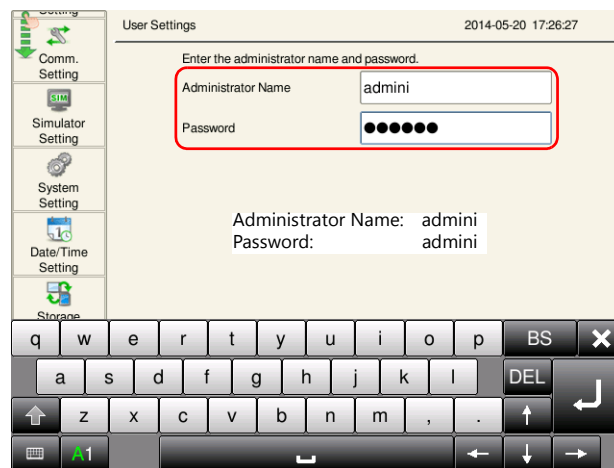

* All users registered to the screen program are granted administrator privileges.

4. The display changes to administrator mode. Press [Add].

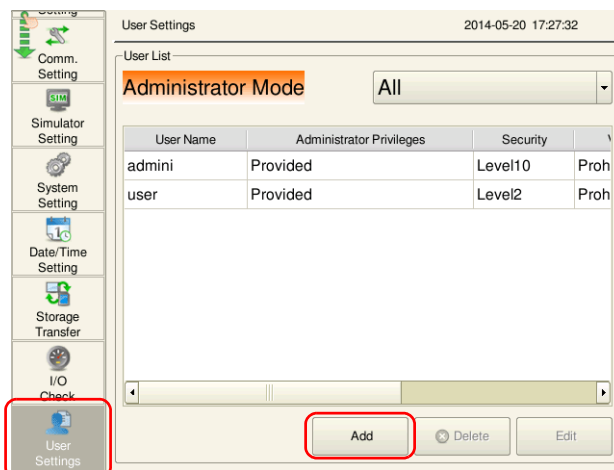

5. Enter "User2" for the user name and "user2" for the password and set security level 3.

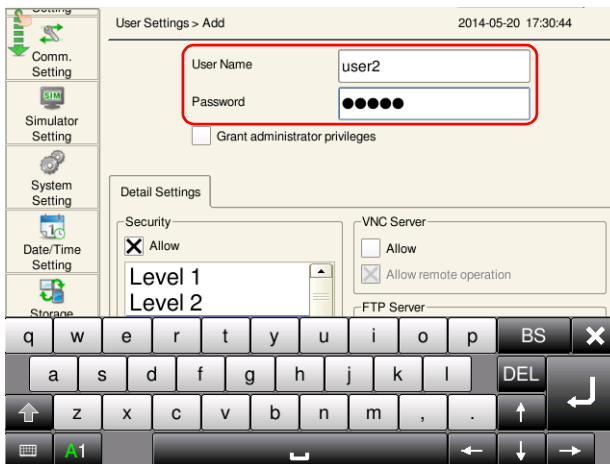

6. Press [OK] to complete the additional registration.

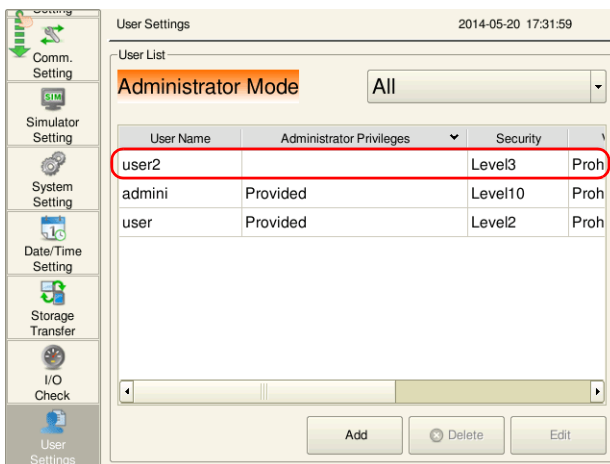

😊 New registrations can be performed by administrators after logging in from [Security] → [User Settings] via the system menu. The procedure is the same as for Local mode.

System menu

Login/Logout

In addition to switches, changes to the security level by logging in/out can also be performed via the system menu.

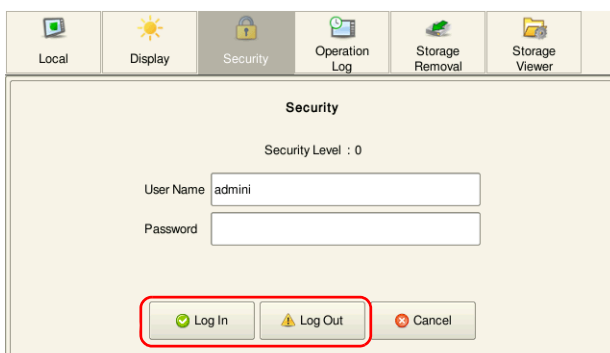

MEMO

MONITOUCH



7 Operation Logs

7.1 Overview

Operation logs capture the history of operations performed on screens, such as switch operations and data updates done using keypads.

The captured history data is saved to the SRAM area and output to an SD card when the SRAM area becomes full. History data can be checked in a list using the operation log viewer.

Operation logs are useful for cause analysis when problems occur as well as reference data for the daily reports of workers.

Operation log viewer

Date / Time	Screen No.	User ID	Security Level	Action
2014/05/20 17:49	5		0	Bit Mom
2014/05/20 17:49	5		0	Bit Alter
2014/05/20 17:49	5		0	DataChg
2014/05/20 17:50				PowerON

Change the backup data on the SD card for display

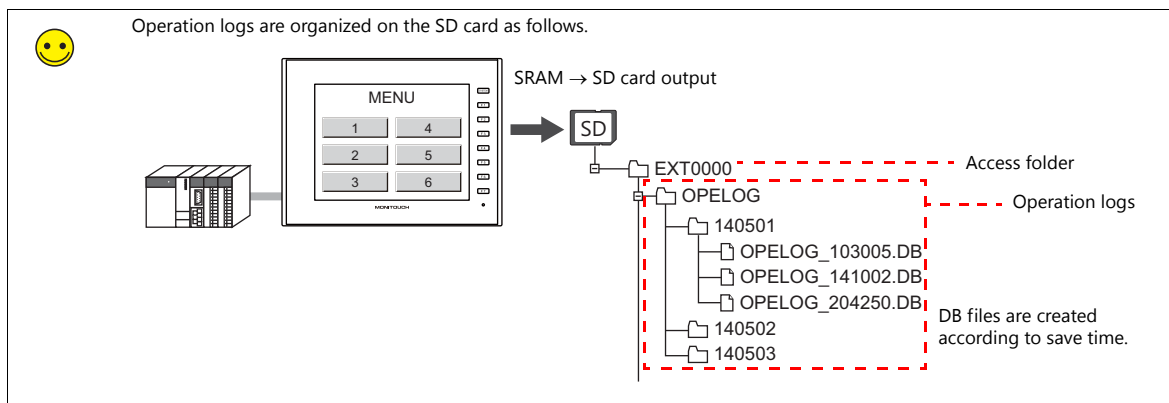

7.2 Screen Example

This chapter explains how to create the following screen.
 Capture a log with switch pressed and a log updated with numerical data using a keypad.

Screen 5

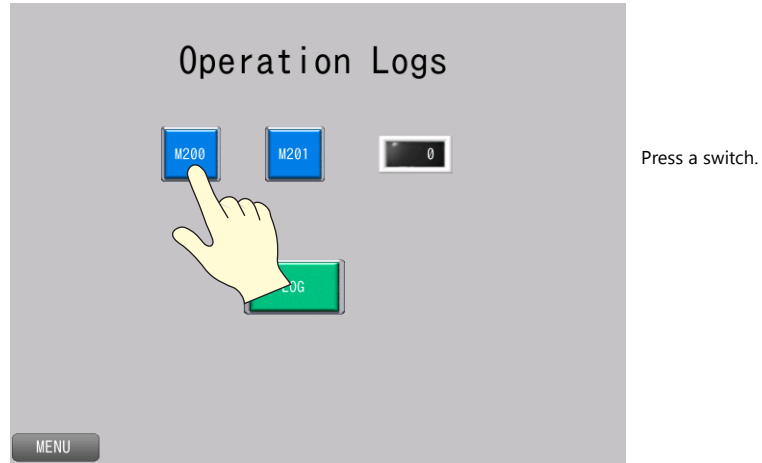

Press the switch that displays the operation log viewer.

Display the operation log viewer and check the operation history.

Date / Time	Screen No.	User ID	Security Level	Action
2014/05/20 17:49	5		0	Bit Mom
2014/05/20 17:49	5		0	Bit Alter
2014/05/20 17:49	5		0	DataChg

Function	Comment	Display Format	Value (Before)	Value (After)
1	SW_00000			
2	SW_00001			
3	Numerical Data	DATA_D_00000	DEC	0 20

7.3 Screen Creation

7.3.1 Operation Log Settings

Configure settings to use operation logs.

1. Click [System Setting] → [Other] → [Operation log Setting]. The [Operation log setting] window is displayed.

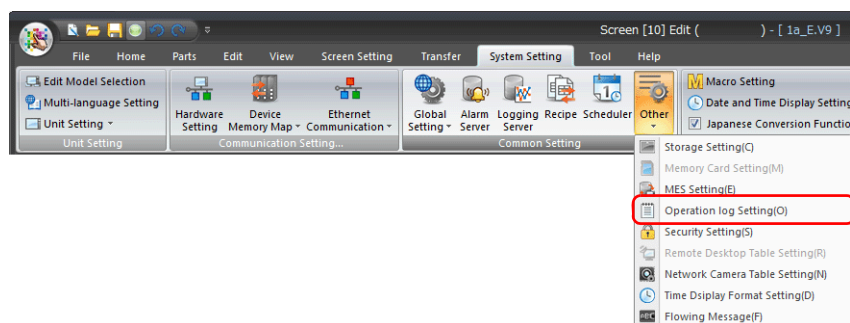

2. Select the [Use operation log function] checkbox and set the following items.

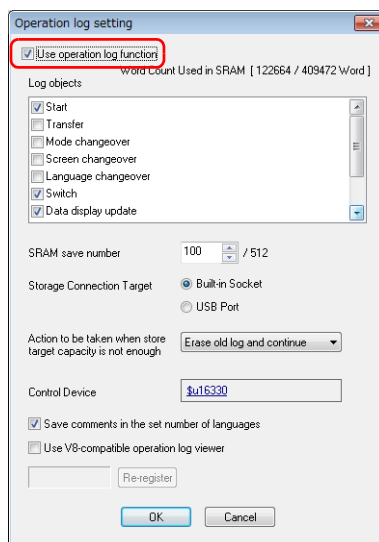

Item	Description	Setting Value
Log objects	Select the checkboxes of the items to save to operation logs. For information on each item, refer to the V9 Series Reference Manual.	Start Switch Data display update
SRAM save number	Set the number of logs to be stored in the SRAM area.	100
Storage Connection Target	Select how to connect the SD card, to which operation logs will be output.	Built-in Socket
Action to be taken when store target capacity is not enough	Select the action to take when the SD card is full.	Erase old log and continue
Control Device	Set the device memory for outputting log data to the SD card.	\$u16330
Save comments in the set number of languages	This setting is available when using the multi-language function and saving items displayed under [Log objects] that support comments. When selected, comments are saved to logs even in multi-language mode (when displaying a language other than the primary language).	Selected
Use V8-compatible operation log viewer	This checkbox is selected automatically when converting from a V8 series screen program.	Unselected

3. Click [OK].

7.3.2 Screen Editing

Placing Switches

1. Click [Home] → [Switch] and place a switch on the screen.
2. Display the switch's settings window and configure the following settings.
 - Char. Prop.

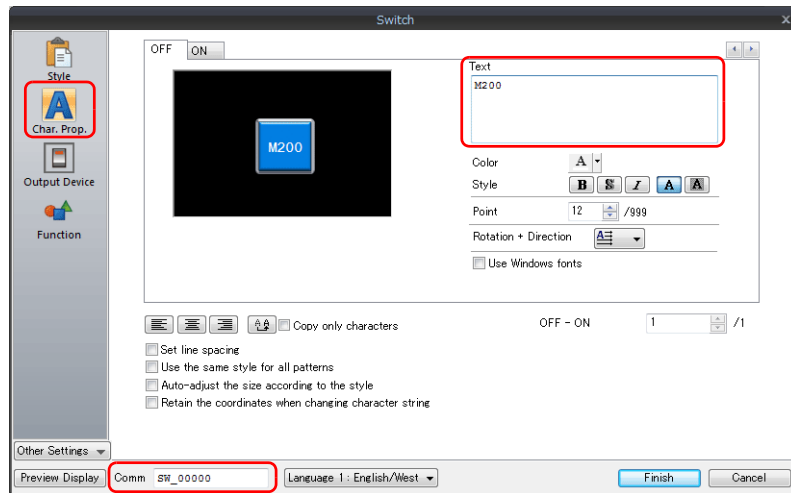

Item	Description	Setting Value
Text	Set the text to be displayed on the switch.	M200
Color Style Point Rotation + Direction Use Windows fonts	Set properties including text color, properties, and text size.	-
Comment	Register a comment for the item. The registered comment is saved to the log.	SW_00000

- Output Device

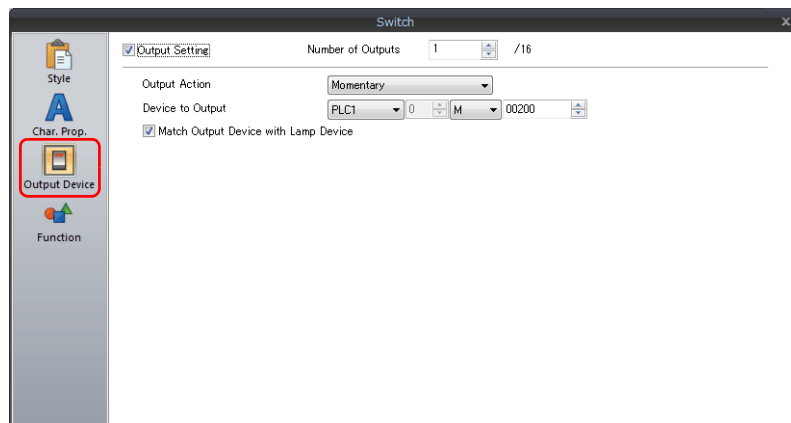

Item	Description	Setting Value
Output Setting	Data is output to device memory when the switch is pressed. A maximum of 16 outputs can be made.	Selected Number of Outputs: 1
Output Action	Set the write operation to perform with respect to the output memory device.	Momentary
Device to Output	Specify the output device memory address.	M200
Match Output Device with Lamp Device	Select this checkbox to set the same device memory for the output device memory and lamp device memory.	Selected

- Detail (display method: [Other Settings] → [Detail])

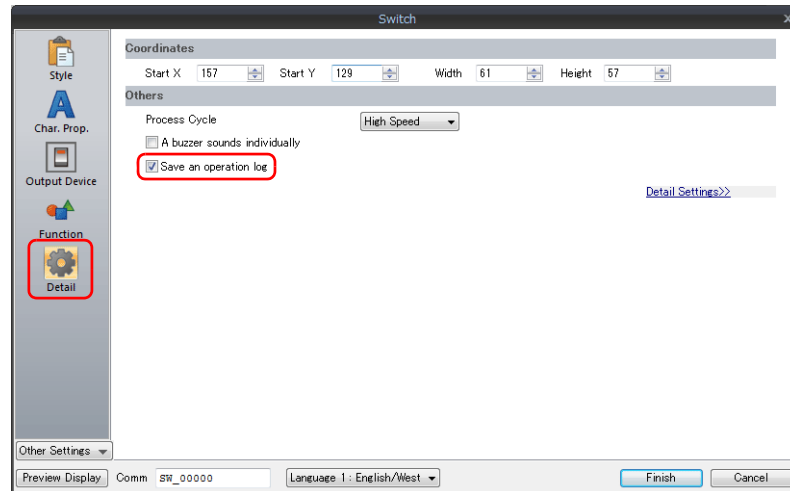

Item	Description	Setting Value
Save an operation log	Save switch operations to logs.	Selected

3. Click the [Finish] button.
4. Create another switch by selecting the current switch and performing a copy and paste.
5. Select the [View] → [Display Environment] group → [Device] checkbox to display the device memory address at the lower left of each switch.

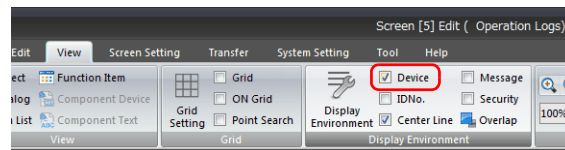

6. Change the switch text, output device memory/operation, and comment to the following.

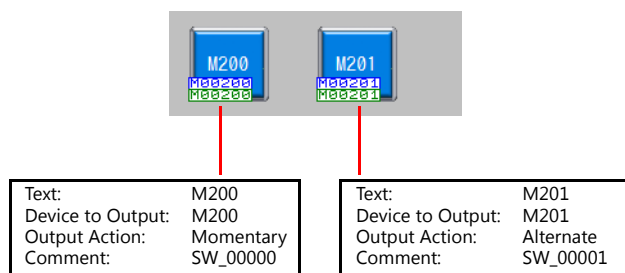

Placing a Numerical Data Display Part

1. Click [Home] → [Data Display] → [Num. Display] and place a numerical data display part on the screen.
2. Display the numerical data display's settings window and configure each item.
 - Contents

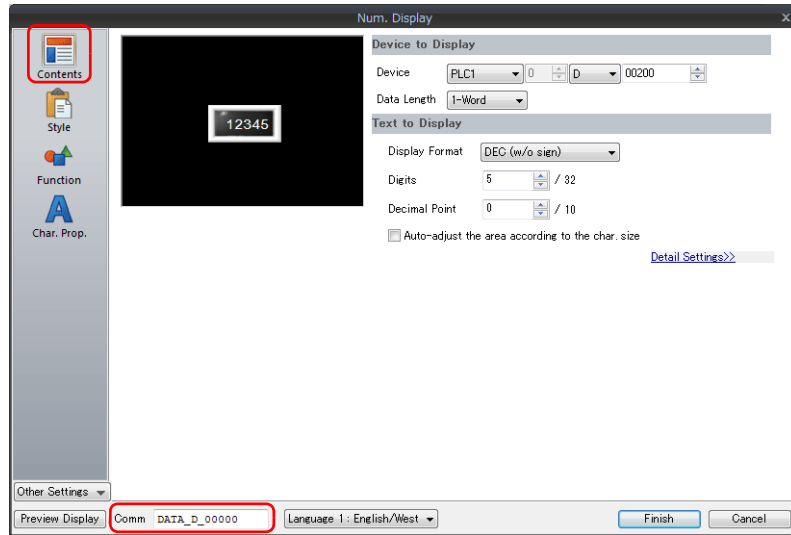

Item	Description	Setting Value
Device	Specify device memory for display and writing.	D200
Data Length	Set the data length of the device memory. 1-Word/2-Word	1-Word
Display Format	Set the format of numbers to be displayed on the screen.	DEC (w/o sign)
Digits	Set the number of digits. 1 to 32	5
Decimal Point	Specify the decimal place. 0: No decimal place, 1 to 10: decimal place positioned at 1st to 10th place respectively	0
Comment	Register a comment for the item. The registered comment is saved to the log.	DATA_D_00000

- Function

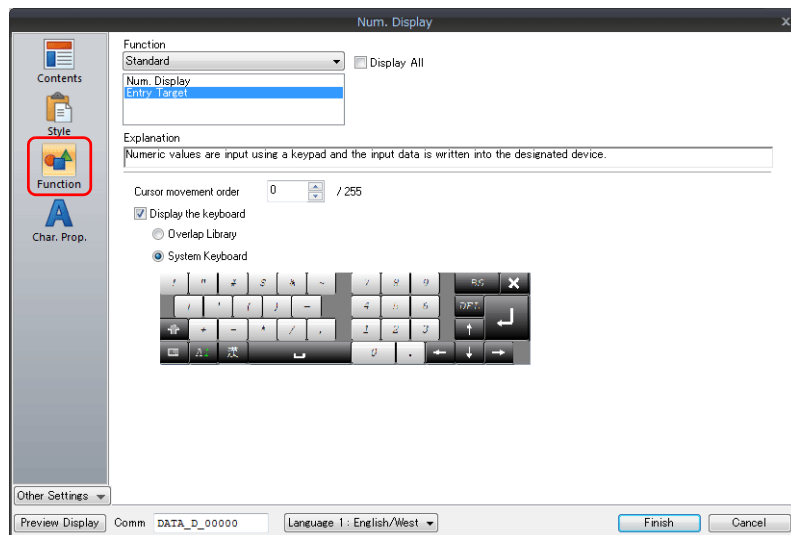

Item	Description	Setting Value
Function	Set the function to use.	Standard Entry Target
Display the keyboard	Available when "Standard" and "Entry Target" are selected. The keypad calling function is added.	Selected System Keyboard

- Detail (display method: [Other Settings] → [Detail])

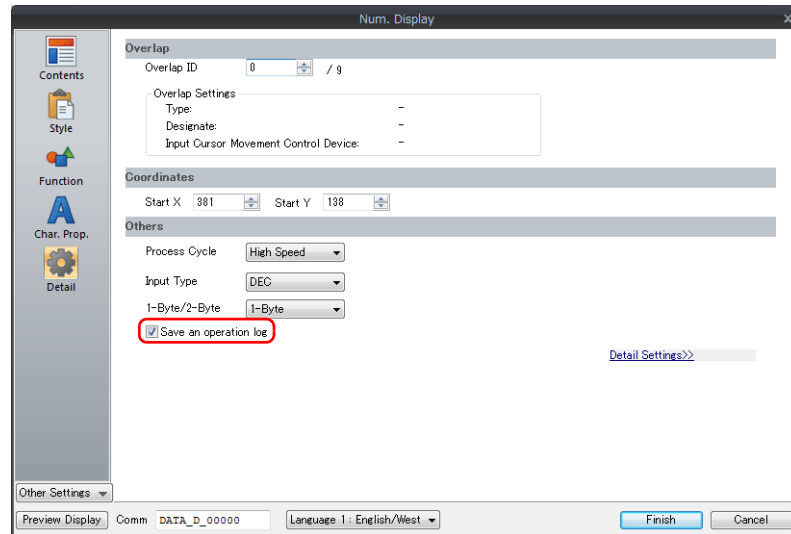

Item	Description	Setting Value
Save an operation log	Save a log of the data updated to the numerical data display.	Selected

3. Click the [Finish] button.



Device to Display:	D200
Function:	Entry Target
Display the keyboard:	Selected, System Keyboard
Comment:	DATA_D_00000

This completes the necessary settings.

Placing a Switch for Calling the Operation Log Viewer

Create a switch for displaying the operation log viewer.

1. Click [Home] → [Switch] and place a switch on the screen.
2. Display the switch's settings window and configure the following settings.
 - Function

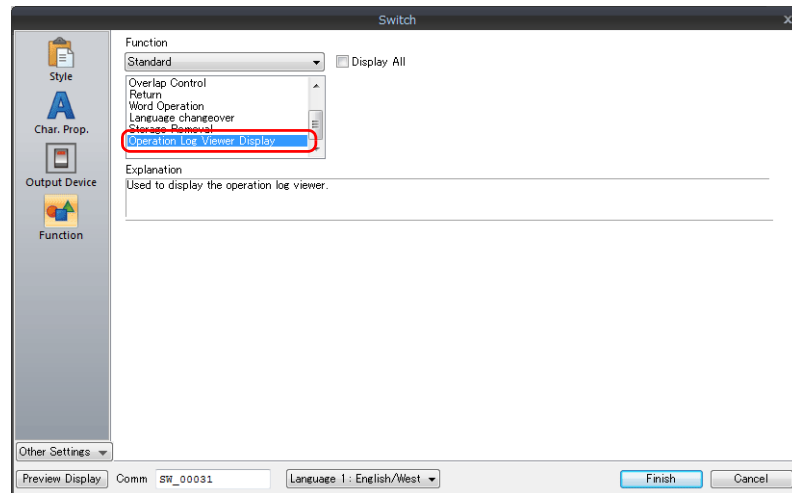

Item	Description	Setting Value
Function	Set the function to use.	Standard: Operation Log Viewer Display

3. Click the [Finish] button.

Placing Text and a Switch for Returning to the Menu Screen

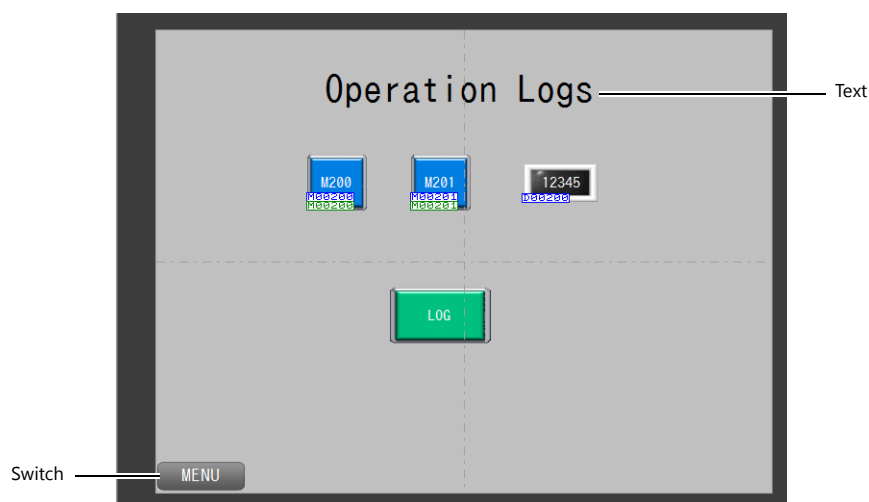

Text

Create the text part of the screen.

1. Click [Home] → [Text] → [Text]. The mouse cursor changes to a crosshair.
2. Click on the screen. A text frame is displayed.
3. Enter text.
4. Click a location on the screen other than the text.
5. Click the text to display its item view window. Adjust the text color and size.

Switch

Create a switch for returning to the menu screen.

1. Click [Home] → [Switch] and place a switch on the screen.
2. Display the switch's settings window and set [Function] to "Screen Change-over" and [Switch to No] to "0".

This completes the screen creation process.

The next section covers screen operation after transferring the screen program to the V9 series unit.

7.4 Checking Unit Operation

7.4.1 List of Used Device Memory Addresses

Device Memory	Description	Remarks
M200	Switch: Output device memory (momentary), lamp device memory	
M201	Switch: Output device memory (alternate), lamp device memory	
D200	Numerical data display: Function: Entry Target	Keypad display enabled

7.4.2 Unit Operation

Checking the Switch Log

1. Press the M200 (momentary) switch.

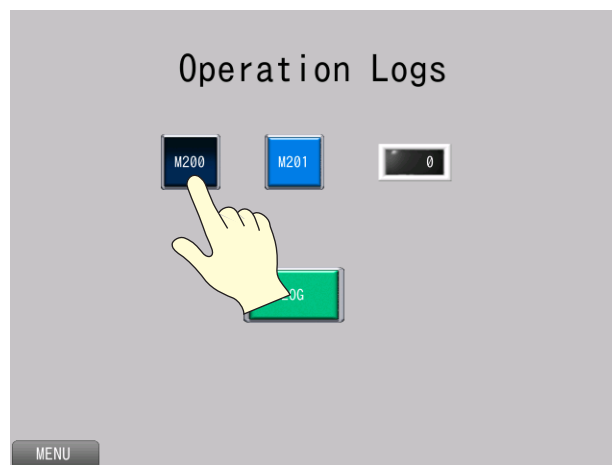

2. Press the M201 (alternate) switch.

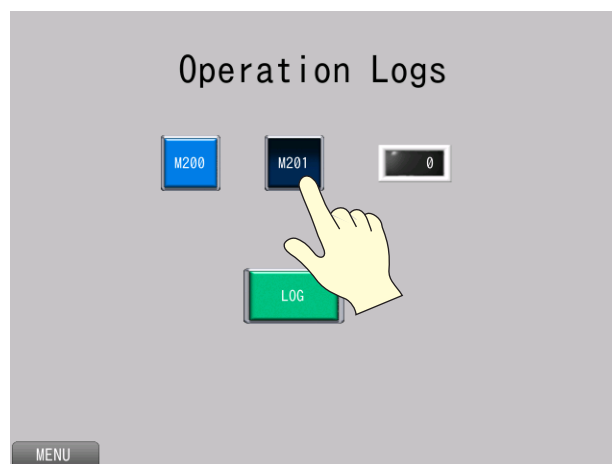

Because M201 is set to alternate, it stays lit up.

- Press the switch that displays the operation log viewer.
Scroll and check that log entries for switches M200 and M201 exist.

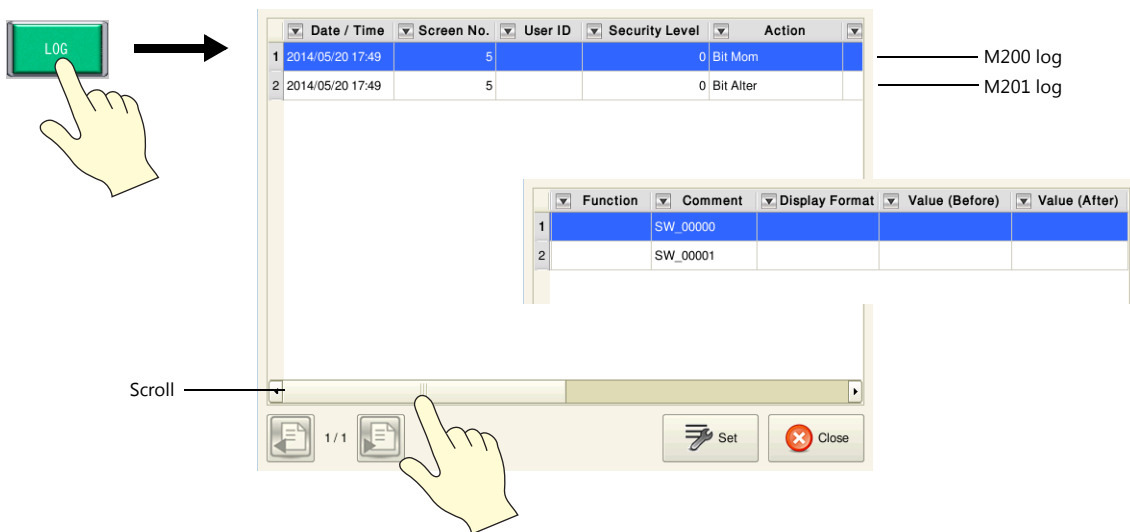

- Press the [Close] switch.

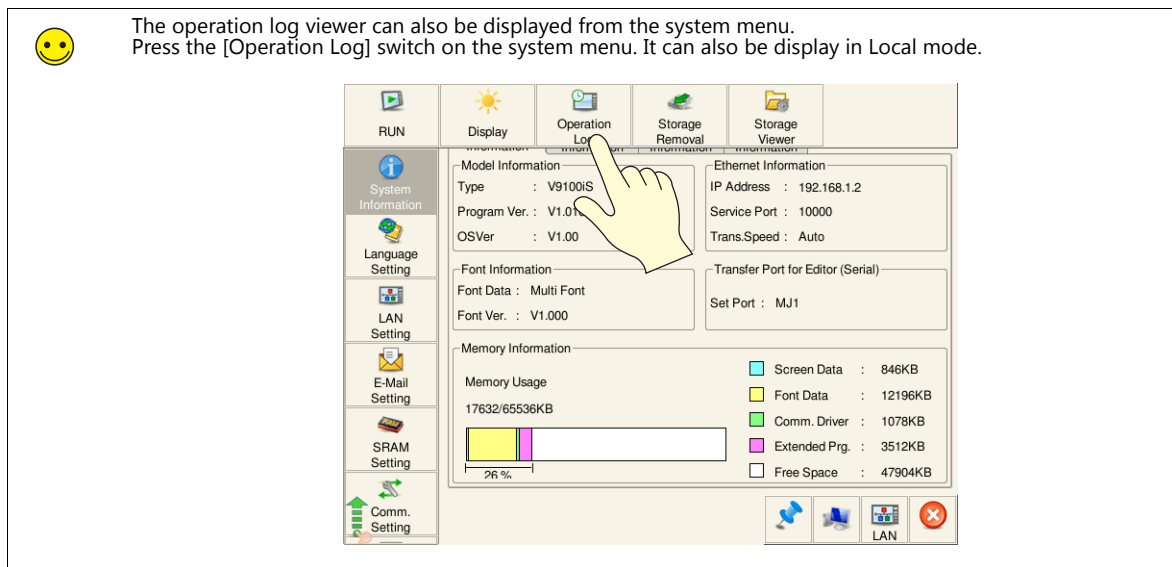

Checking the Data Update Log

1. Press the numerical data display (D200). This displays the system keyboard and highlights the value.

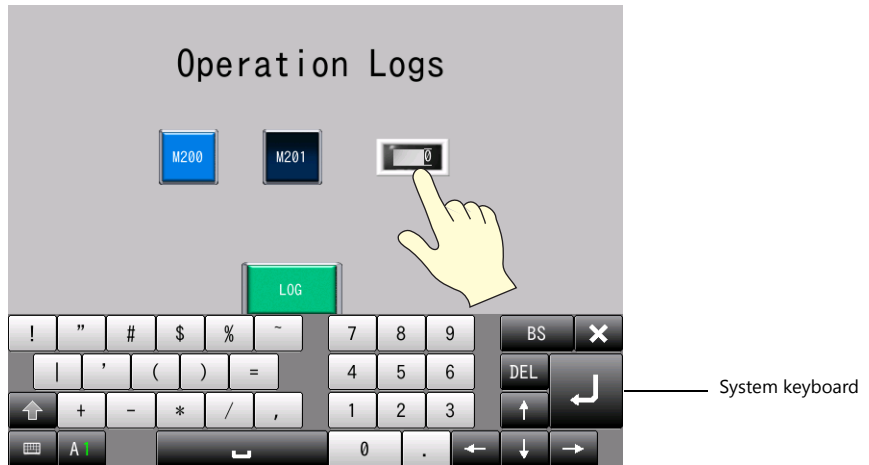

2. Enter "20" with the system keyboard and write the value by pressing the [Enter] key.

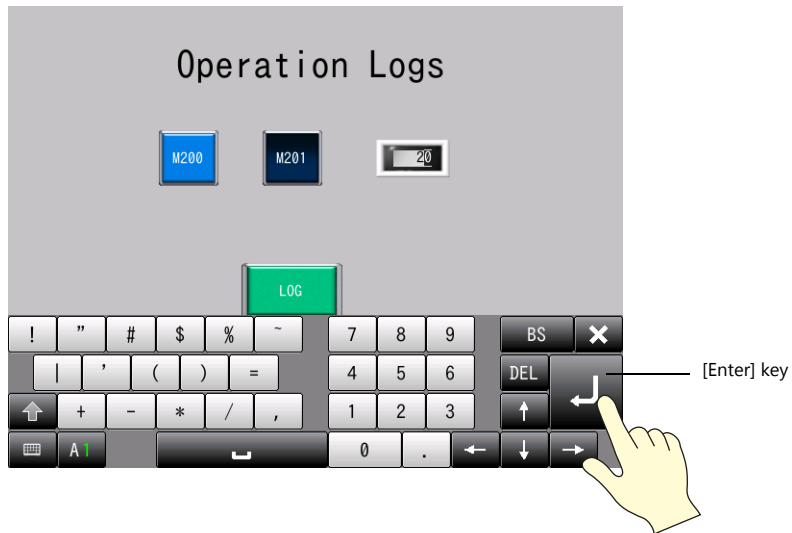

3. The system keyboard disappears and "20" appears on the numerical data display.
4. Press the switch that displays the operation log viewer. Scroll and check that log entries before and after the data value update exist.

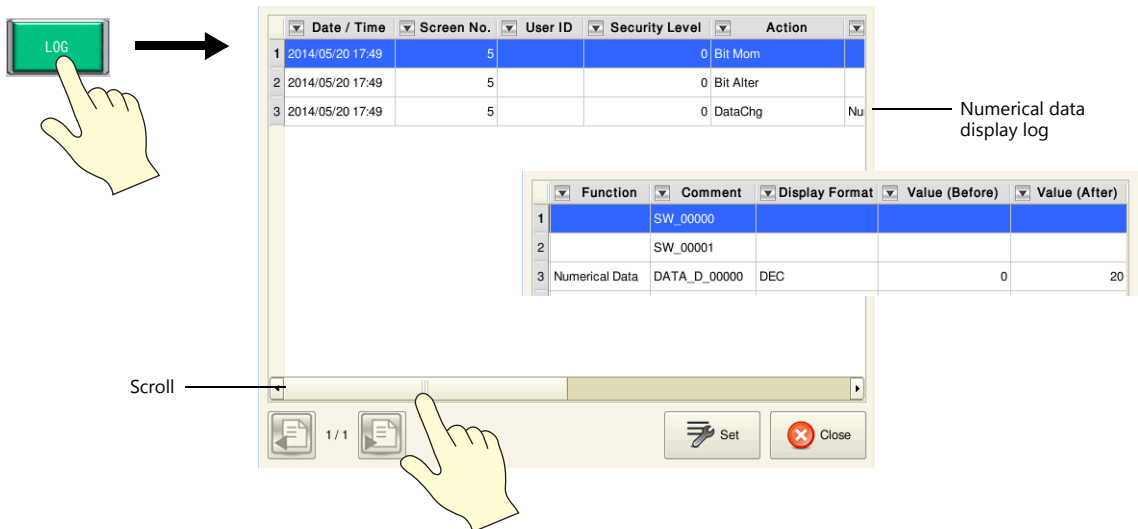

5. Press the [Close] switch.

Checking the Startup Log

1. Turn OFF power to MONITOUCH and then turn it ON again.
2. Press the switch that displays the operation log viewer.
Check that a power ON log entry exists.

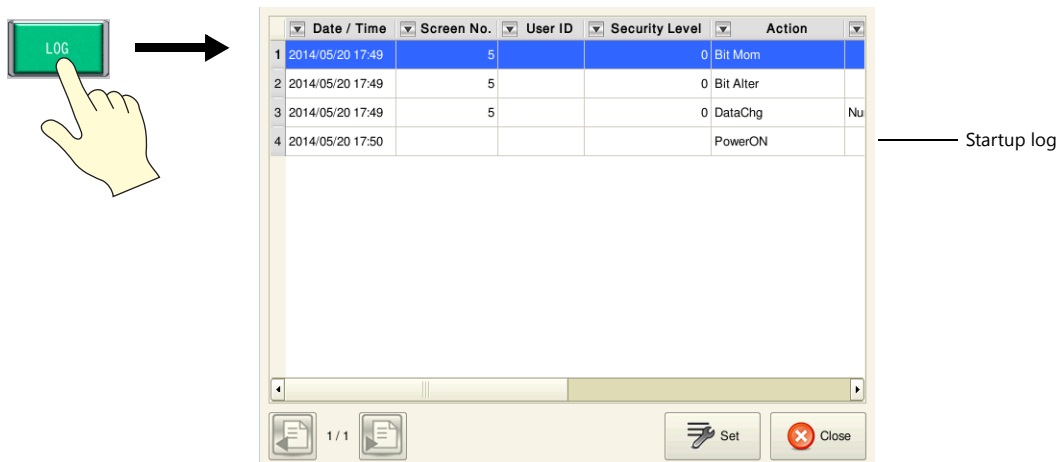

3. Press the [Close] switch.

Checking the Security Log

1. Changeover to the security screen (screen No. 4).
2. Log in with "user" and "admini" and press switches M150, M151, and M152.
3. Return to the operation log screen.
4. Press the switch that displays the operation log viewer.
Check that log entries for user ID and security level exist.

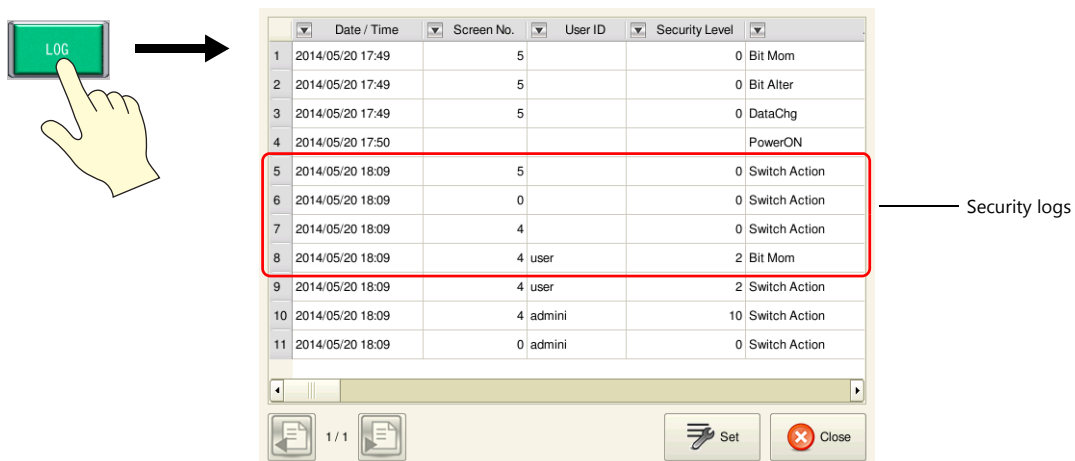

5. Press the [Close] switch.

Showing/Hiding Items

The items to be displayed in the operation log viewer can be selected.

1. Press the [Set] button in the operation log viewer. A setting window is displayed.

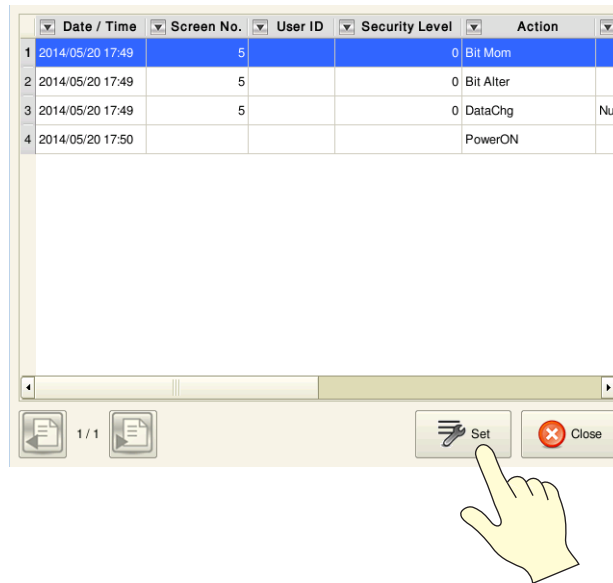

2. On the [Item Display Setting] tab window, remove the [x] mark from items to be hidden, change the date and time display formats, and press [OK].

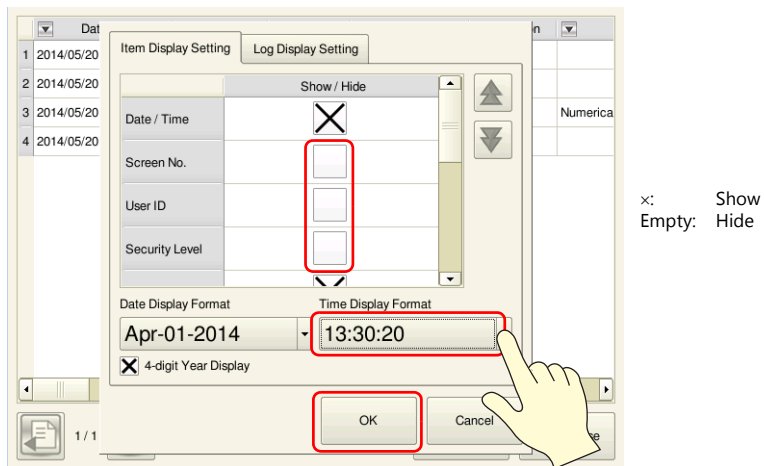

x: Show
 Empty: Hide

3. The operation log viewer changes to the set display.

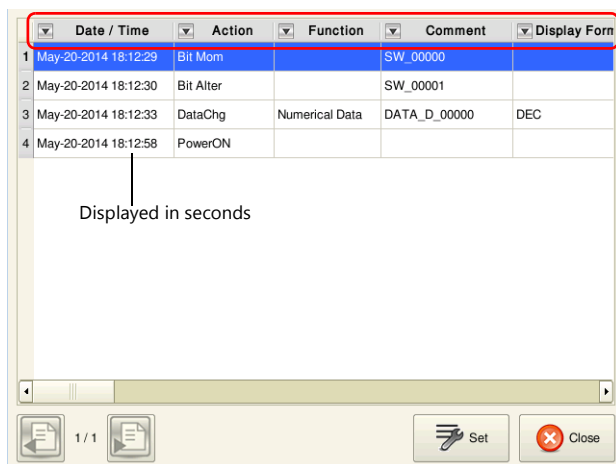

Screen No., User ID,
 and Security Level are
 hidden.

Changing Order of Display

The order of display in the operation log viewer can be set.

1. Press the [Set] button in the operation log viewer. A setting window is displayed.

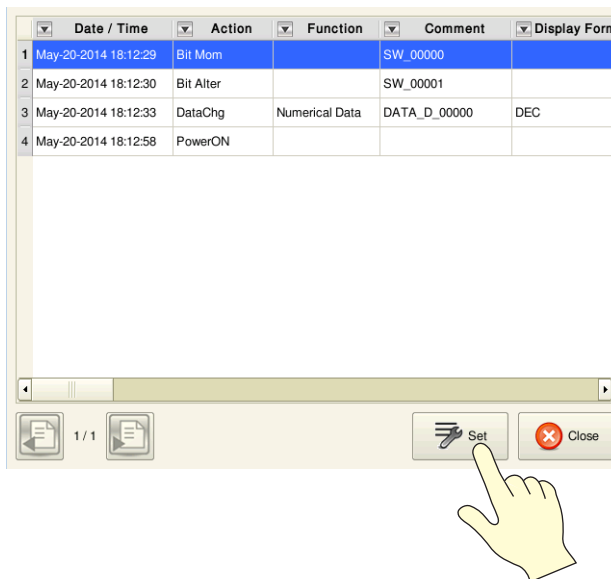

2. Select an item on the [Item Display Setting] tab and press the [↑] or [↓] switch. After reordering item positions, press [OK].

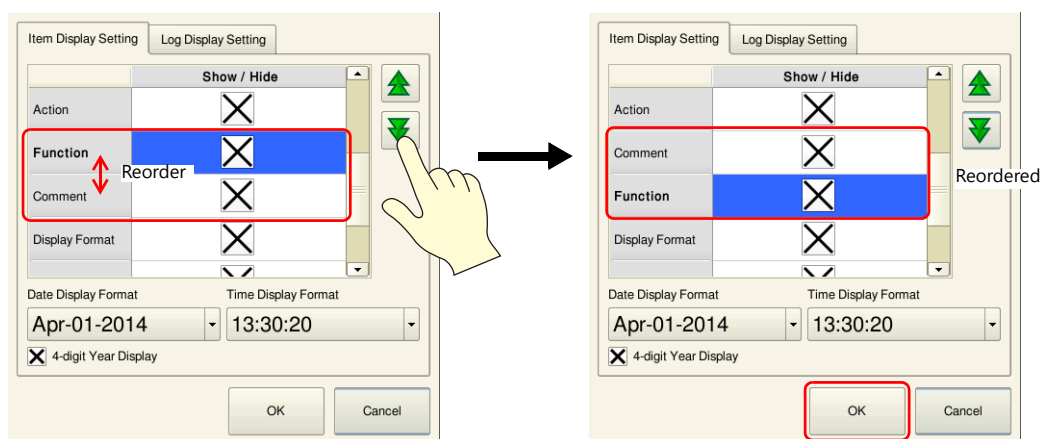

3. The operation log viewer changes to the set display.

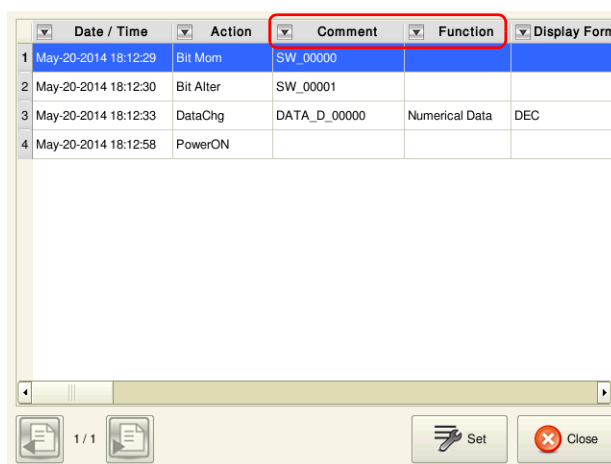

[Comment] and [Function] positions are reordered.

Log Display Settings

The logging targets for display in the operation log viewer can be selected.

1. Press the [Set] button in the operation log viewer. A setting window is displayed.

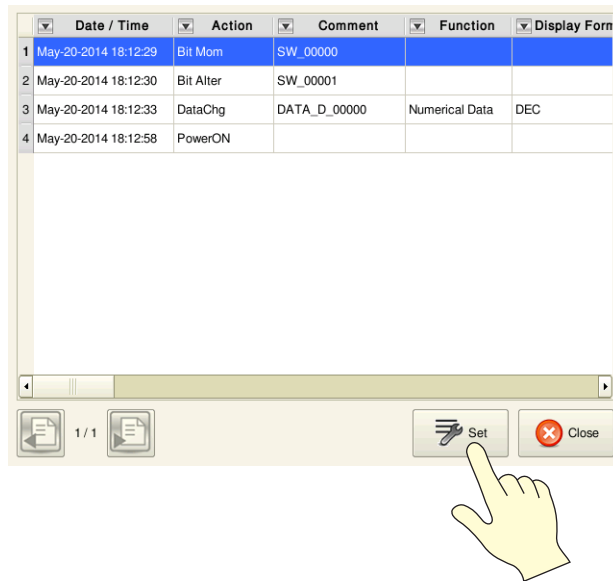

2. On the [Log Display Setting] tab, remove the [x] mark from logs to be hidden and press [OK].

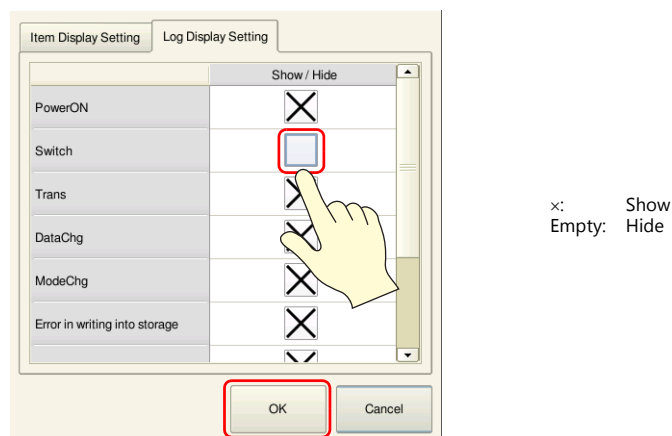

3. The operation log viewer changes to the set display.

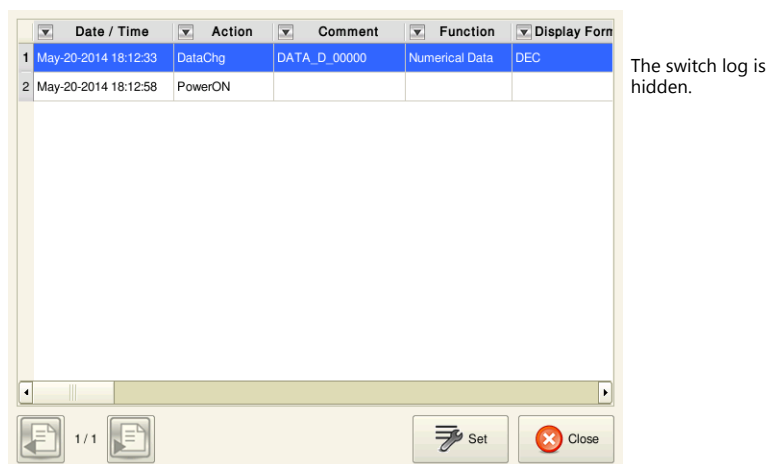

8 Changing Languages

8.1 Overview

A maximum of 16 languages can be used on the same screen just by switching the text for display. Because fonts are stored on the V9 series unit in advance, the language for display can be switched to in RUN mode. Select a base language (font) first and then edit the screen using text that can be displayed in the selected font.

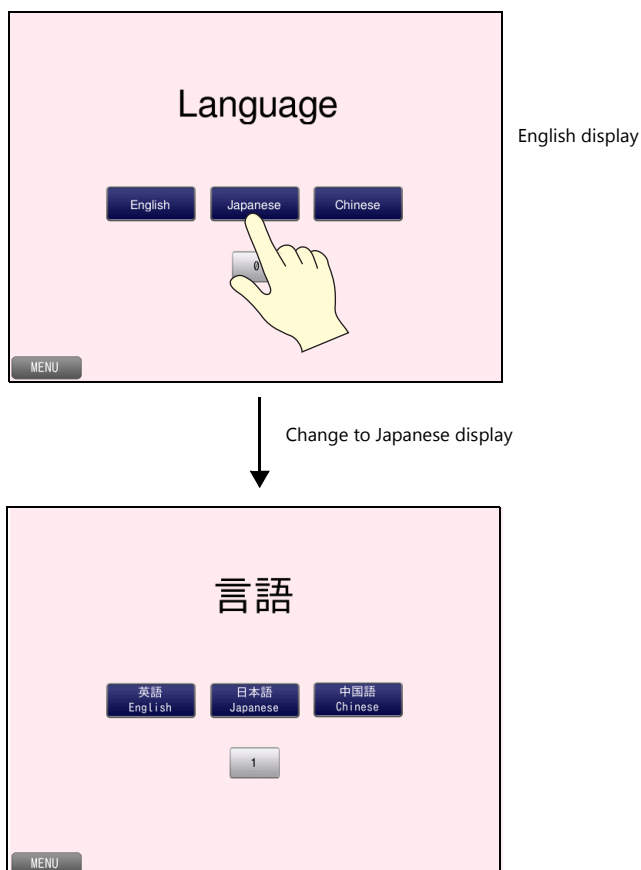

8.2 Screen Example

This chapter explains how to create a language switching screen for English, Japanese, and Chinese (simplified).

Screen No. 6

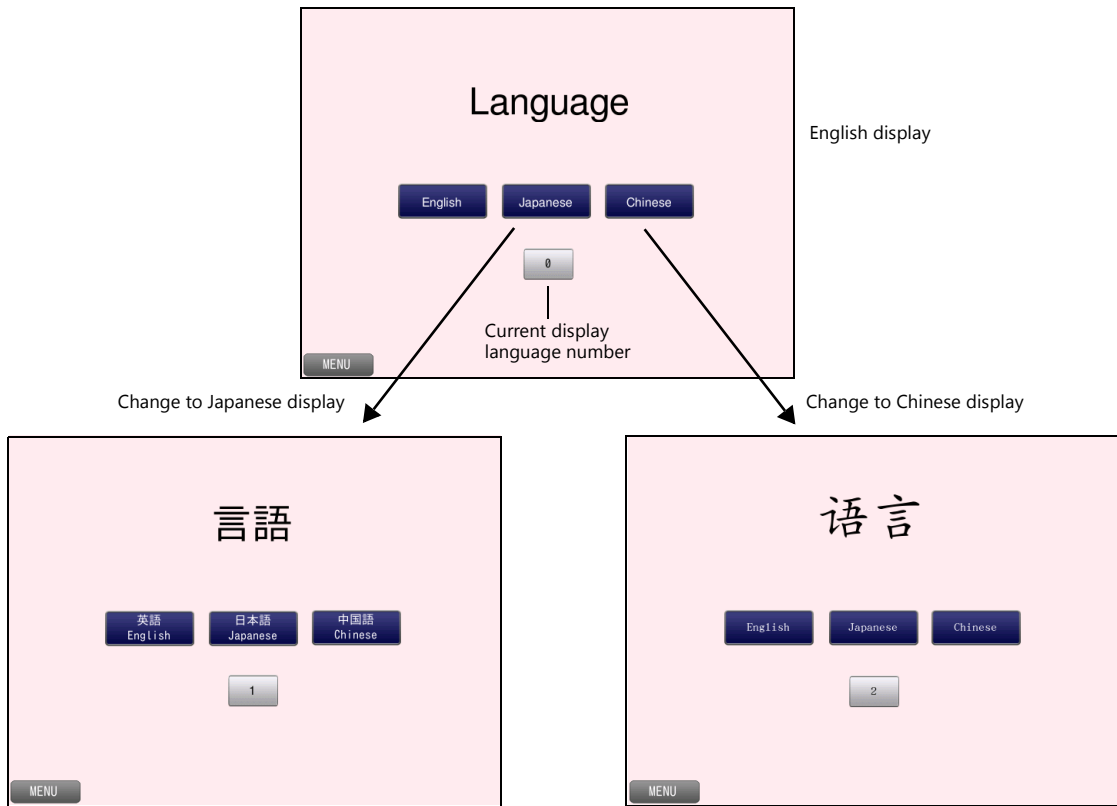

8.3 Screen Creation

8.3.1 Font Settings

Set the font to use on screens.

1. Click [System Setting] → [Multi-language setting].
2. Display the [Font Setting] window and configure the following settings.

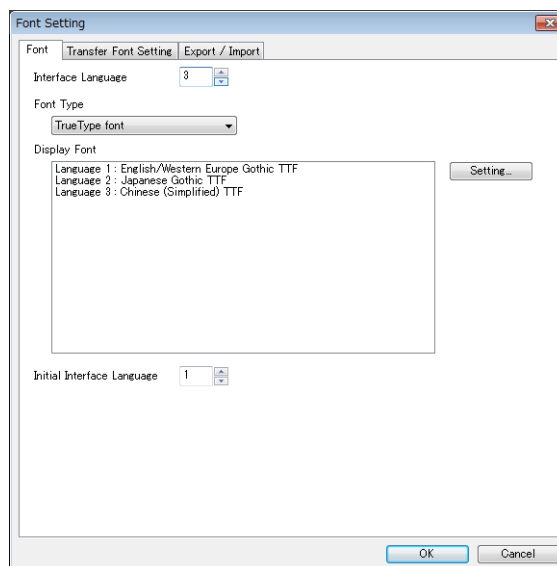

Item	Description	Setting Value
Interface Language	Set the number of interface languages. 1 to 16	3
Font Type	Select either [TrueType font] or [Bitmap font].	TrueType font
Display Font	Set the display languages using the [Font Setting] button.	English/Western Europe Gothic TTF Japanese Gothic TTF Chinese (Simplified) TTF
Initial Interface Language	Select the language to be displayed immediately after screen program transfer. 1 to 16	1

This completes the necessary settings.



Transfer Font Setting

Select the checkboxes of the fonts required on the V9 series unit. More fonts selected for transfer results in less capacity available for the screen program.
Do not select fonts that are not necessary.

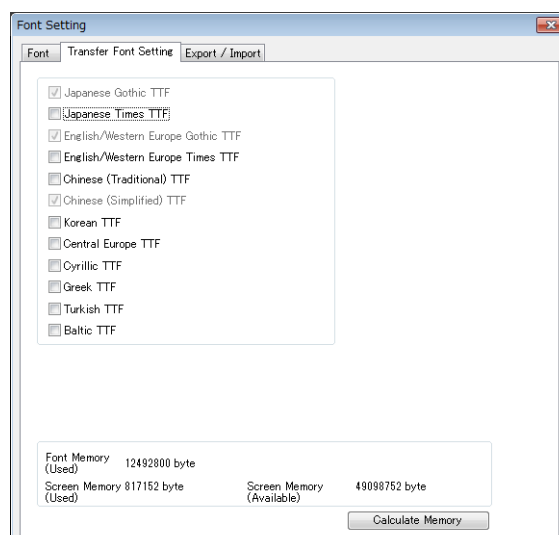

8.3.2 Screen Editing

Before Editing Languages

To edit each language on the PC, each input language must be added to the PC. This section uses Windows 7 to explain the procedure for adding Japanese and Chinese (simplified) (IME installation).

1. In Windows 7, click [Start] → [Control Panel].
2. Click [Change keyboards or other input methods] or [Region and Language].
3. Click [Change keyboards] on the [Keyboards and Languages] tab window to display the [Text Services and Input Languages] window.

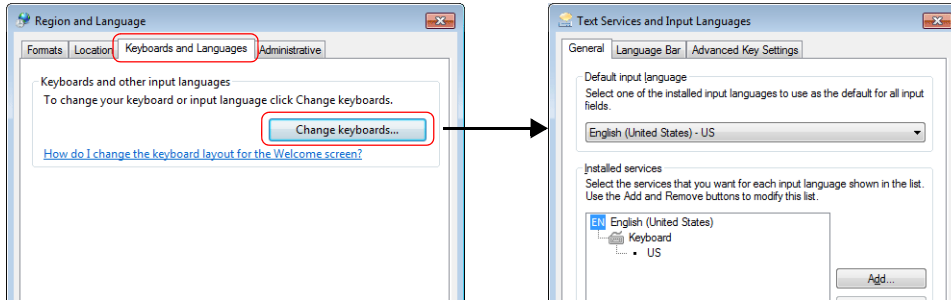

4. Click [Add].
5. Select the following checkboxes and click [OK].

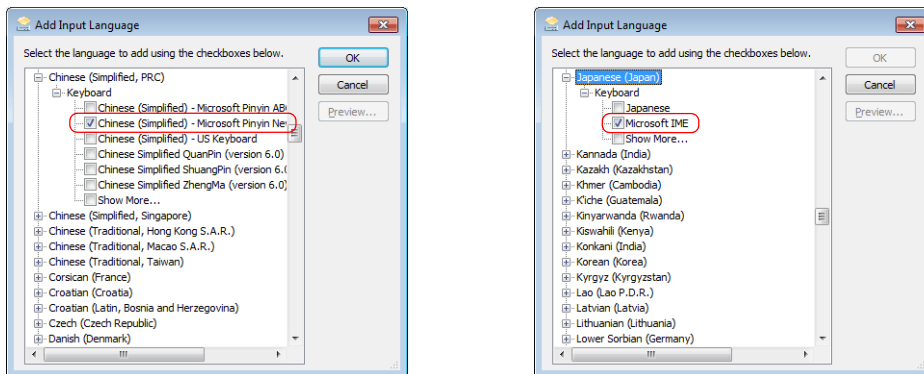

6. Check that Japanese and Chinese are added and click [OK].

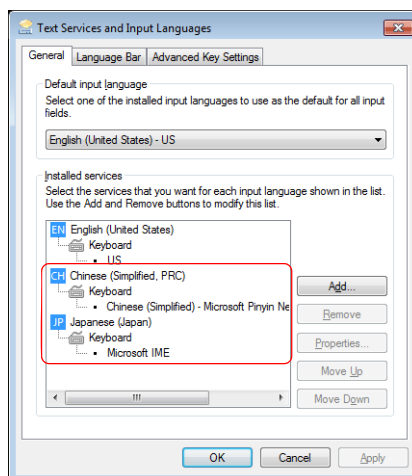

The necessary settings have been completed. Japanese and Chinese can be entered by switching between languages on the PC's language bar.

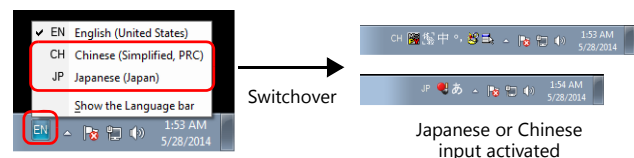

Placing Text

1. Click [Home] → [Text] → [Text] and place a text part on the screen.
2. Set the following items in the item view window of the text part.

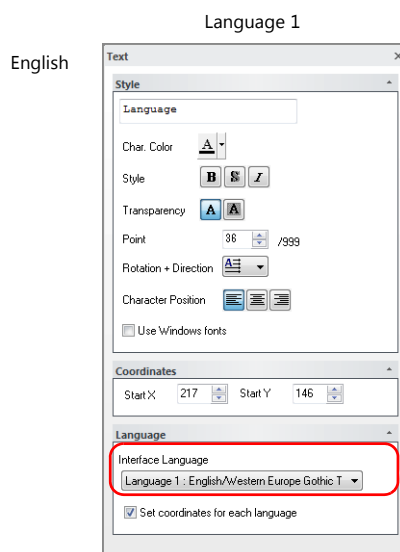

* Character properties (text size and color) can be set for each language.

Item (Language 1)	Description	Setting Value
Text frame	Set the text to be displayed on the text part.	Language
Char. Color	Set the text color.	Black
Style	Set the text style.	–
Point	Set the text size.	36
Rotation + Direction Character Position Use Windows fonts	Set the text properties.	–
Interface Language	Change the language for editing on the screen.	Language 1: English/Western Europe Gothic TTF
Set coordinates for each language	Set the position of the text frame of each language.	Selected

3. Change [Interface Language] to "Language 2" and switch from "EN" to "JP" on the language bar at the lower right of the PC screen.
4. Configure the following settings.

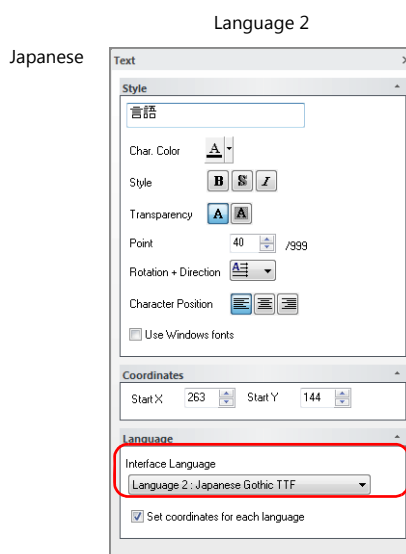

Item (Language 2)	Description	Setting Value
Text frame	Set the text to be displayed on the text part.	言語
Char. Color	Set the text color.	Black
Point	Set the text size.	40

- Change [Interface Language] to "Language 3" and switch from "JP" to "CH" (Chinese (Simplified, PRC)) on the language bar at the lower right of the PC screen.

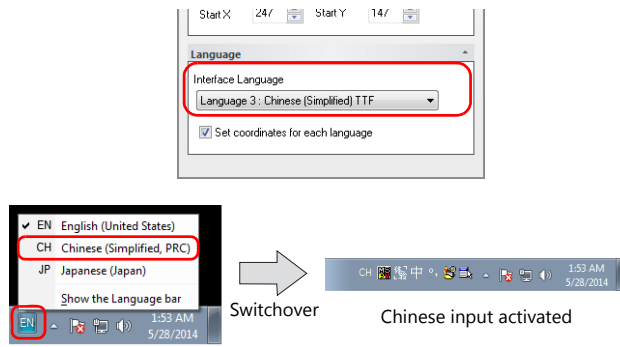

- Enter "yuyan" in the text frame, select "语言", and then accept by pressing the [Enter] key. Configure the following settings.

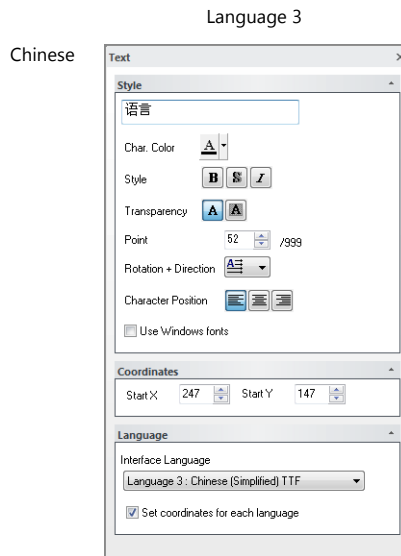

Item (Language 3)	Description	Setting Value
Text frame	Set the text to be displayed on the text part.	语言
Char. Color	Set the text color.	Black
Point	Set the text size.	52

- Switch between the display language using the following methods and adjust the text position for languages 1 to 3.

- [Interface Language] in the item view window of a text part

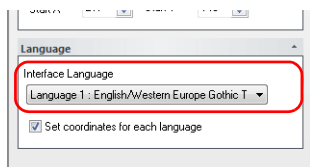

- [View] → [Display Change] group menu

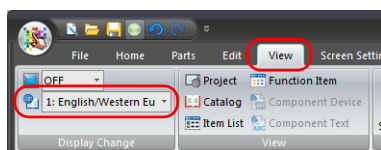

- [View] → [Display Environment]

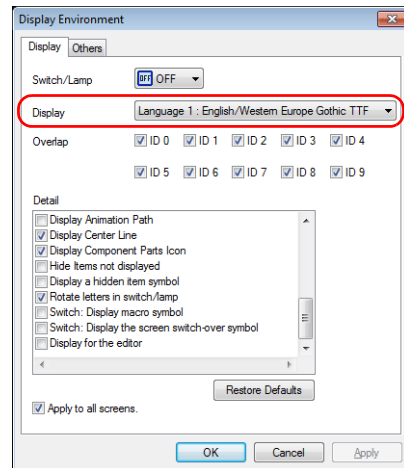

This completes the necessary settings.

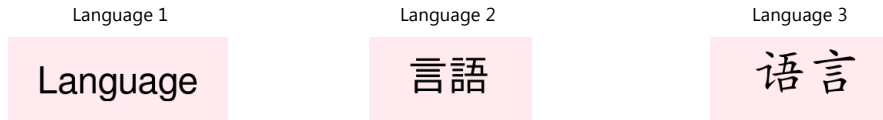

The following methods are also available for editing multiple languages instead of editing items directly.

For details, refer to the V9 Series Reference Manual.

- [Multi-language Edit] window ([Home] → [Registration Item] → [Multi-language])
A list is displayed that allows editing while comparing languages. This list can be copied and pasted into Excel.

[Multi-language Edit] window

No.	1:Japanese	2:English	3:Chinese (Simplified)	4:Korean
0	[確認]	[Confirm]	[确认]	[확인]
1	[言語を切り替えます。]	[Language will be swi	[转换语言。]	[언어를 바꿉니다.]
2	[よろしいですか?]	[OK?]	[可以吗?]	[좋습니다?]
3	[はい]	[Yes]	[可以]	[예]
4	[いいえ]	[No]	[不行]	[아니오]
5	[日本語]	[Japanese]	[日文]	[일본어]
6	[英語]	[English]	[英文]	[영어]
7	[中国語]	[Chinese]	[中文]	[중국어]
8	[韓国語]	[Korean]	[韓文]	[한국어]
9	[1つの画面で、複数の言語	[It is possible to im	[在一个画面上可以转换	[한 화면에서 여러 언어

- Export/Import ([System Setting] → [Multi-language Setting] → [Export/Import] tab window)
After exporting, edit each language in Excel. After editing, import the language data.

Example of a TXT export file

	Language 2	Language 3	Language 4
1	[Confirm]	[确认]	[확인]
2	[Language will be switche	[转换语言。]	[언어를 바꿉니다.]
3	[OK?]	[可以吗?]	[좋습니다?]
4	[Yes]	[可以]	[예]
5	[No]	[不行]	[아니오]

Placing Switches (Language Change-over)

1. Click [Home] → [Switch] and place a switch on the screen.
2. Display the switch's settings window and configure the following settings.
 - Style
Set the switch design.
 - Char. Prop.

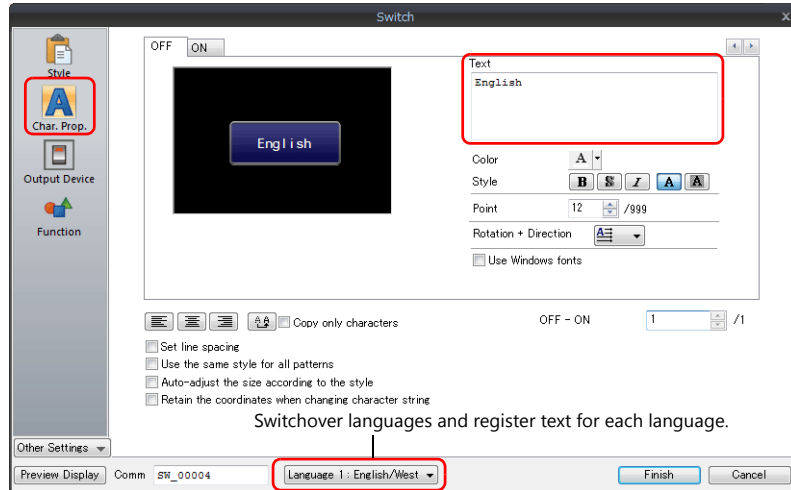

Item	Description	Setting Value
Text	Set the text to be displayed on the switch. Register text for each language using the language switching menu.	Language 1 English Language 2 英語 (English) Language 3 English
Color Style Point Rotation + Direction Use Windows fonts	Set properties including text color, properties, and text size.	—

- Function

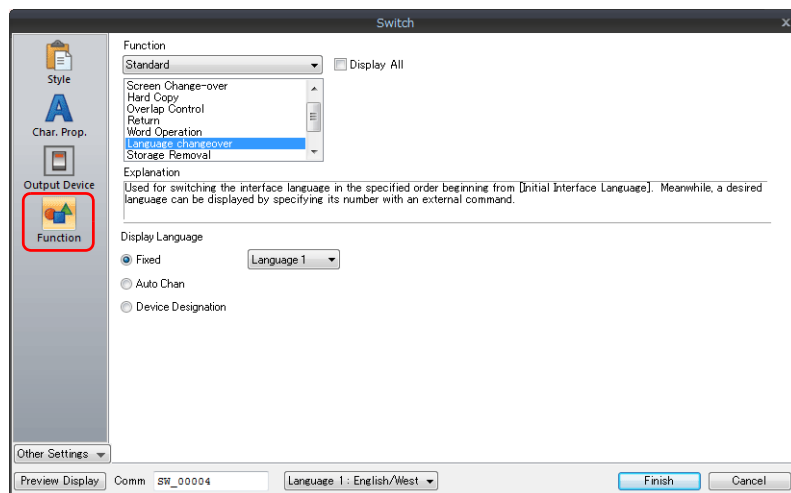

Item	Description	Setting Value
Function	Set the operation to perform when the switch is pressed.	Standard: Language change-over
Display Language	Set the language to display when the switch is pressed.	Fixed Language 1

3. Click the [Finish] button.

4. Select the switch and click [Edit] → [Multi-copy]. The [Multi Copy] window is displayed.

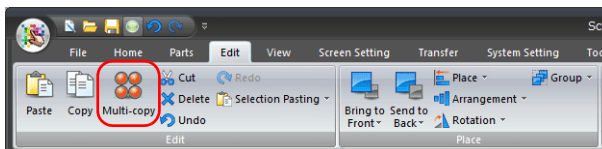

5. Configure the following settings and click [OK].

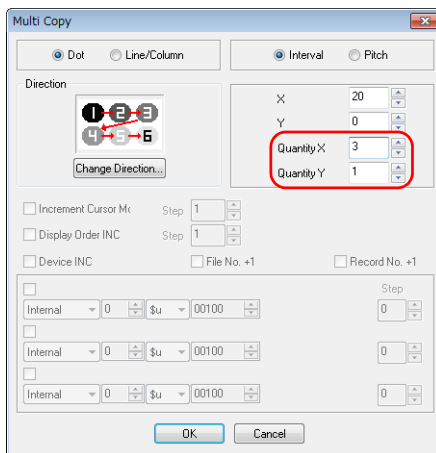

[Quantity X]: 3
[Quantity Y]: 1

6. This makes multiple copies of the switch. Change the text and function of the copied switches.

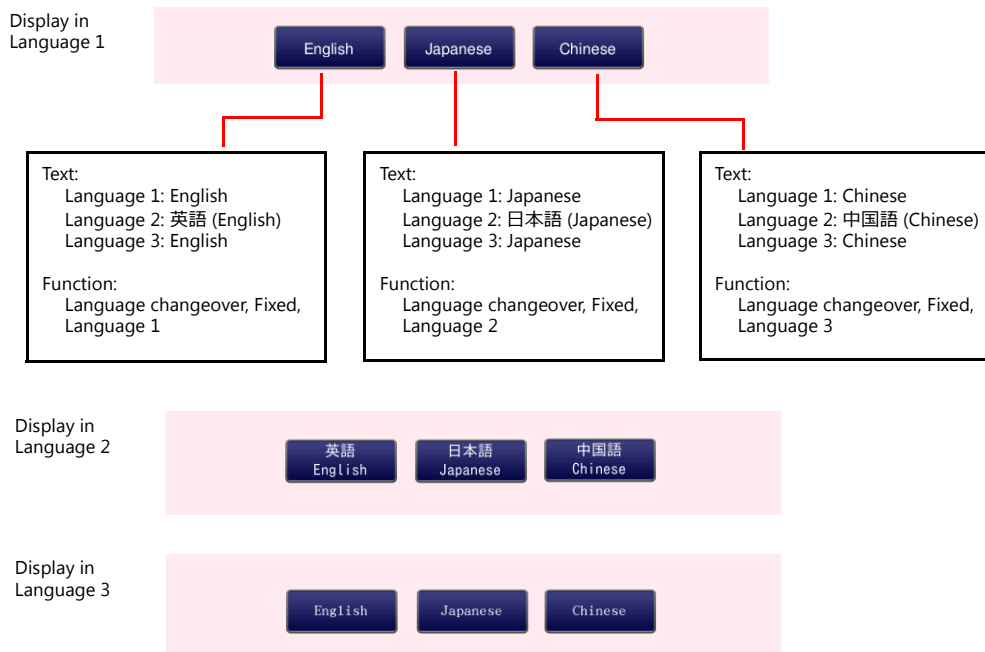

This completes the switch creation process.

Placing a Numerical Value Display Part (For Displaying the Current Language No.)

1. Click [Home] → [Data Display] → [Num. Display] and place a numerical data display part on the screen.
2. Display the numerical data display's settings window and configure the following settings.
 - Contents

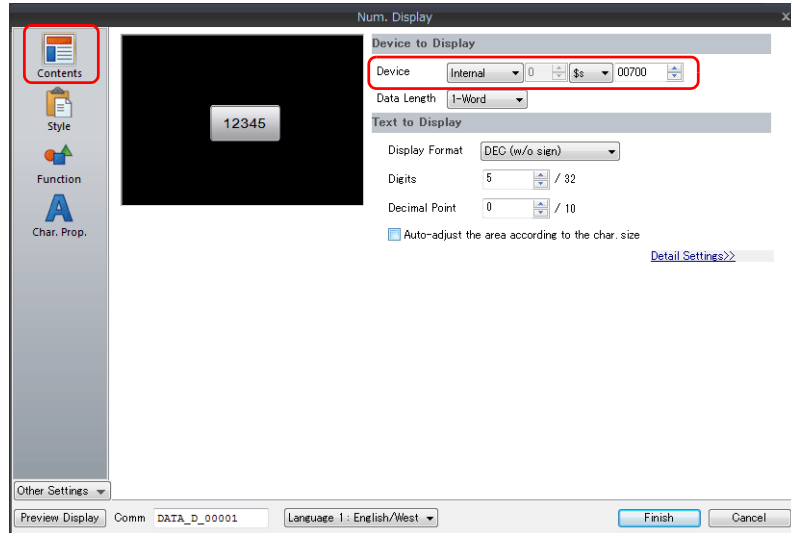

Item	Description	Setting Value
Device to Display	Specify the device memory address for monitoring.	Internal \$s700

3. Click the [Finish] button.

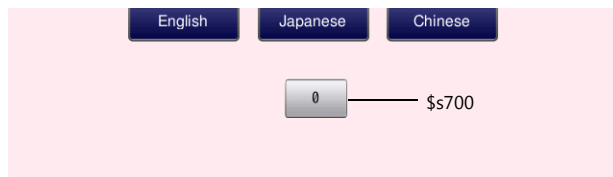

This completes the numerical data display creation process.

Placing a Switch for Returning to the Menu Screen

Create a switch for returning to the menu screen.



1. Click [Home] → [Switch] and place a switch on the screen.
2. Display the switch's settings window and set [Function] to "Screen Change-over" and [Switch to No] to "0".

This completes the screen creation process.

8.3.3 Redraw Timing

When the interface language is switched, the screen is redrawn. Set the items that are executed when this happens.

1. Click [Screen Setting] → [Screen Setting] → [Unhide].
2. Configure the following settings.

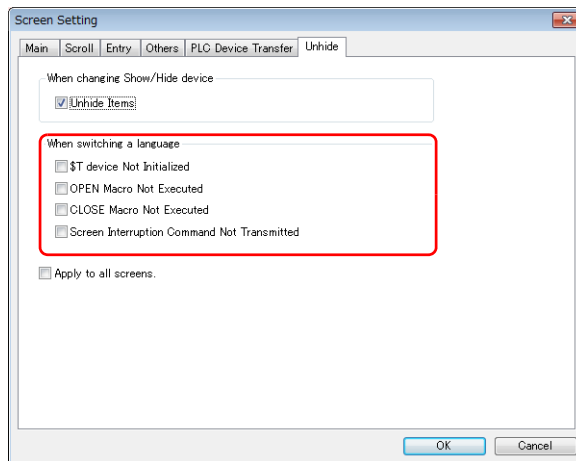

Item	Description	Setting Value										
When switching a language	Set the items to execute when switching languages.											
	<table border="1"> <thead> <tr> <th>Execution Item</th> <th>Location of Setting</th> </tr> </thead> <tbody> <tr> <td>Open macro Close macro</td> <td>Screen, multi-overlap library</td> </tr> <tr> <td>Cycle macro</td> <td>Screen</td> </tr> <tr> <td>\$T device memory zero clear</td> <td>Screen</td> </tr> <tr> <td>Screen interrupt command transfer</td> <td>Screen, PLC: universal serial transfer</td> </tr> </tbody> </table>		Execution Item	Location of Setting	Open macro Close macro	Screen, multi-overlap library	Cycle macro	Screen	\$T device memory zero clear	Screen	Screen interrupt command transfer	Screen, PLC: universal serial transfer
	Execution Item	Location of Setting										
	Open macro Close macro	Screen, multi-overlap library										
	Cycle macro	Screen										
	\$T device memory zero clear	Screen										
Screen interrupt command transfer	Screen, PLC: universal serial transfer											
Unselected												

3. Click [OK].

8.4 Checking Unit Operation

Press a switch to change the display language.

1. Press the [Japanese] switch. (Display language No. 0)



2. The display language changes to Japanese. (Display language No. 1)
Press the [Chinese] switch.



3. The display language changes to Chinese. (Display language No. 2)



9 Device Memory Map

9.1 Overview

Device Memory Map

This memory map is used when you need to read and write data between devices connected to the V9 series unit.

This can be easily configured without the need for a sequence program.

Device memory maps are processed in the background so operations occur without affecting the screen process cycle.

Device memory maps can be executed periodically or by changing a PLC trigger bit from OFF to ON.

Example: Periodic reading every 5 seconds

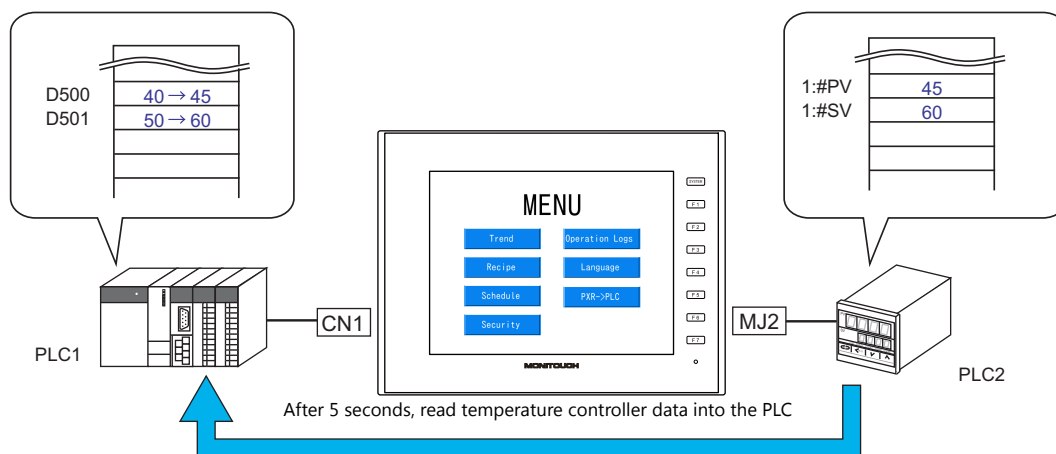

PLC2 device memory map number 0

No.	PLC2 Device	Name	Data Type	>> Target Device 1	>> Target Device 2
0	1:#31001	Process value (PV)	Word	D00500	
1	1:#41003	SV value controlled on face panel	Word	D00501	
2					
3					
4					

Maximum of 128 entries can be registered in a single device memory map.
(Device memory map numbers 0 to 31 (32 total) per logical port)

Types of Device Memory Map Execution

The following types are available.

- Periodical: Execute data reading/writing at a set time
 - Periodical reading
 - Periodical writing
- Synchronized: Execute data reading/writing when the set trigger bit of a control device memory changes from OFF to ON
 - Synchronized reading
 - Synchronized writing

9.2 Screen Example

This chapter explains how to create a screen for transferring data from a Fuji Electric PXR to PLC every 5 seconds using device memory number 0.

Screen No. 7

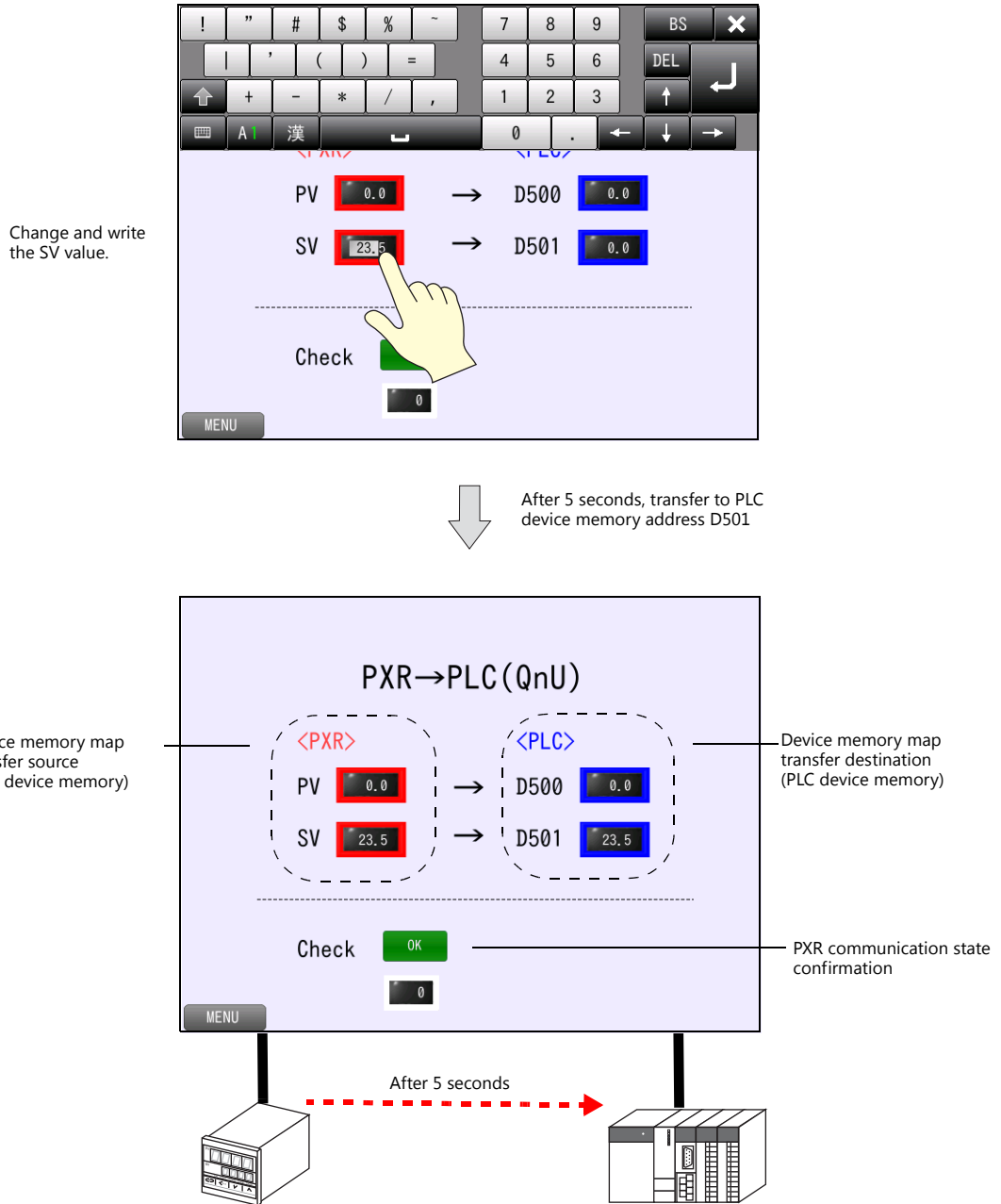

9.3 Connecting to the Fuji Electric PXR

9.3.1 V-SFT Settings

1. Click [System Setting] → [Hardware Setting].
2. Double-click the empty display of PLC2 or MJ2 to display the [Connection Device Selection] window. Select the following model and connection port and click [OK].

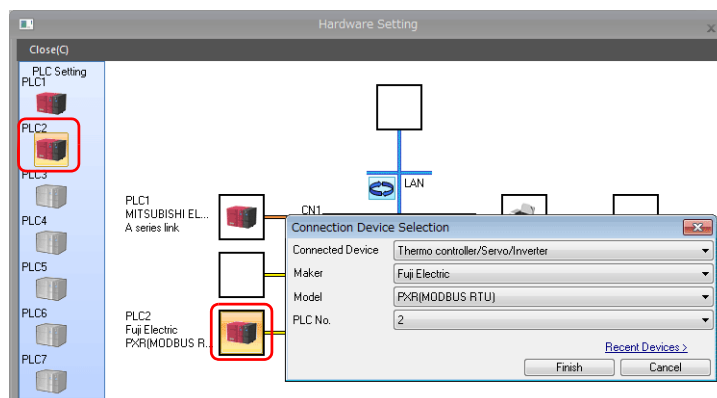

Item	Description	Setting Value
Connected Device	Select the connected device (PLC, temperature controller etc.).	Thermo controller/Servo/Inverter
Maker	Select the manufacturer and model of the connected device.	Fuji Electric PXR (MODBUS RTU)
Model		
PLC No.	Select the connection port on the V9 series unit.	MJ2

3. The PLC2 properties are displayed. Configure the following settings.

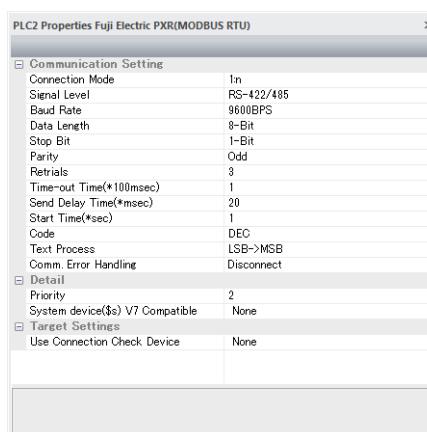

Item	Description	Setting Value
Connection Mode	1:1, 1:n, Multi-link2	1:n
Signal Level	RS-422/485	RS-422/485 (fixed)
Baud Rate	9600 bps	9600 bps (fixed)
Data Length	8-Bit	8-Bit (fixed)
Stop Bit	1-Bit	1-Bit (fixed)
Parity	None, Odd, Even	Odd
Comm. Error Handling	Stop, Continue, Disconnect	Disconnect

This completes the configuration of settings.

9.3.2 PXR Settings

For more information, refer to V9 Series Connection Manual 1.

9.4 Screen Creation

9.4.1 Editing Device Memory Maps

Edit device memory map number 0.

1. Click [System Setting] → [Device Memory Map] → [PLC2] and click [OK] for No. 0.

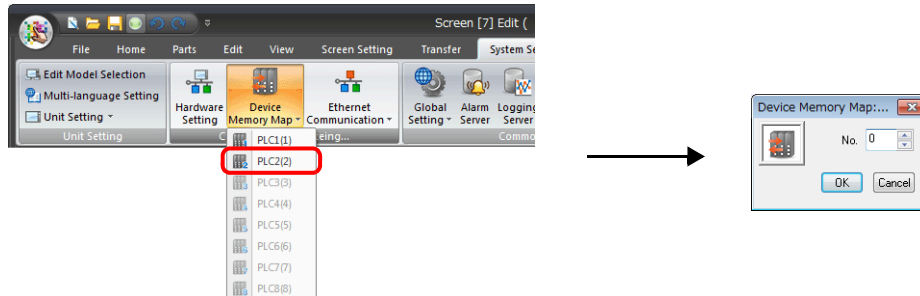

2. The [Device Memory Map:PLC2[0]] window is displayed.

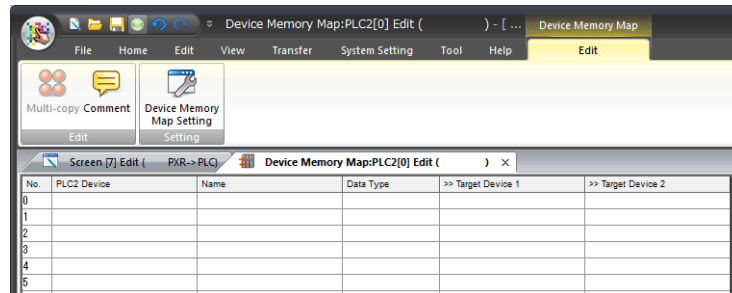

☹ A device memory map has numbers 0 to 31 (32 total) with respect to a single logical port and 128 addresses can be registered to each device memory map.

3. Click [Edit] → [Device Memory Map Setting] to display the [Device Memory Map Setting [0]] window. Configure the following settings.

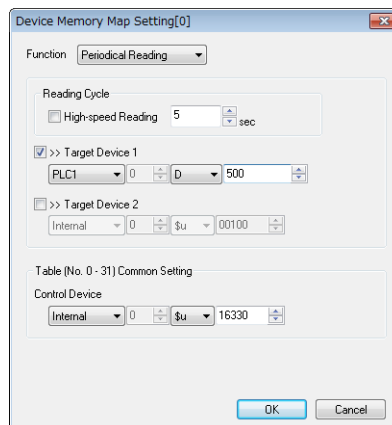

Item	Description	Setting Value
Function	Set the timing and direction of transfer.	Periodical Reading
Reading Cycle	Set this item when "Periodical Reading" or "Periodical Writing" is selected. Set the transfer cycle.	5 sec
Target Device 1	Specify the device memory address of the transfer destination.	Selected D500
Target Device 2	Set this item when transferring to a device memory other than [Target Device 1].	Unselected

Item	Description	Setting Value
Control Device	Set this item when "Synchronized Reading" or "Synchronized Writing" is selected. Execute transfer according to the state of the control device memory bit. All device memory map numbers from 0 to 31 are controlled.	–

- Click [OK] to close the window.
- Double-click the 0th row cell under [PLC2 Device] and set [Port No.] to "1".
Click the [Open] button and select "31001 Process value (PV)".

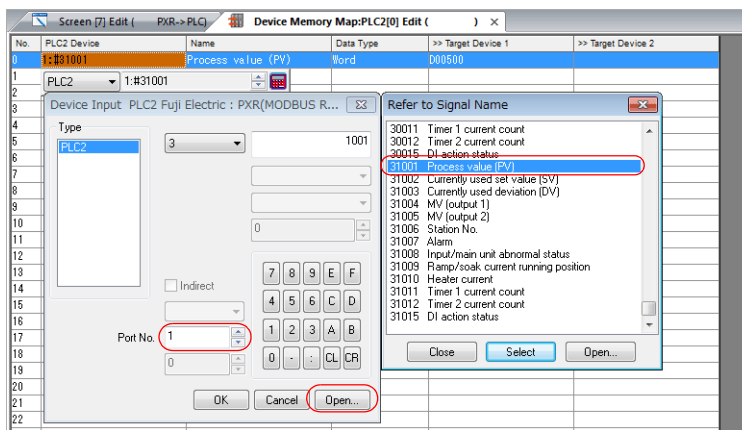

- "1: #31001" is registered to the 0th row. (Leave [Data Type] set to "Word".)

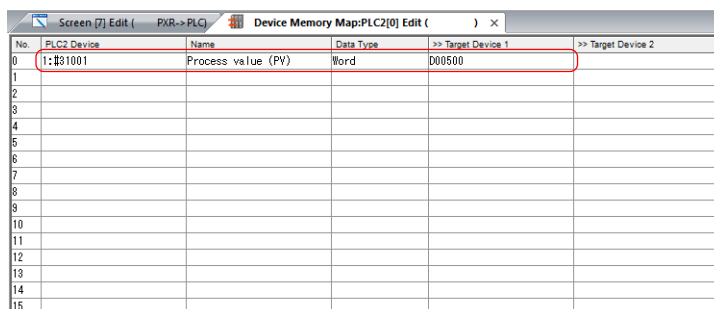

- Set the 1st row to "1: #41003" (SV value controlled on face panel).

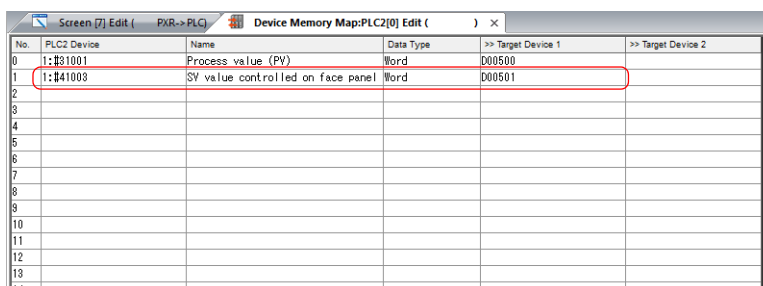

This completes the device memory map settings.

9.4.2 Screen Editing

Placing Numerical Data Displays Parts (for Monitoring)

Place numerical data display parts for monitoring each device memory.

PXR Device Memory (Transfer Source)

1. Click [Home] → [Data Display] → [Num. Display] and place a numerical data display part on the screen.
2. Display the numerical data display's settings window and configure the following settings.
 - Contents

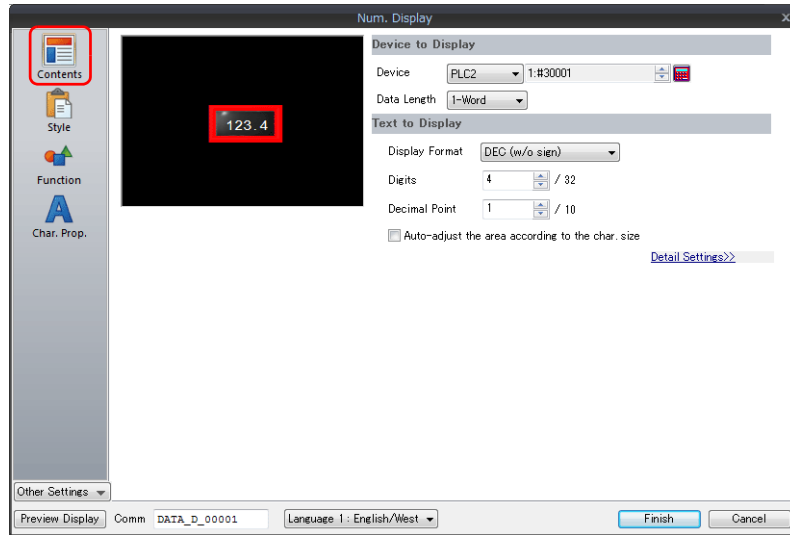

Item	Description	Setting Value
Device to Display	Specify the device memory address for monitoring.	PLC2 1: #31001
Decimal Point	Specify the decimal place.	1

3. Click the [Finish] button.
4. Select the numerical data display and copy and paste.
5. Display the settings window of the pasted numerical data display and configure the following settings.

- Contents

Item	Description	Setting Value
Device to Display	Specify the device memory address for monitoring.	PLC2 1: #41003
Decimal Point	Specify the decimal place.	1

- Function

Item	Description	Setting Value
Function	Set the function to use.	Standard: Entry Target
Cursor movement order	Set the order to move the cursor when the UP/DW keys on the keypad are pressed.	0
Display the keyboard	Available when "Standard" and "Entry Target" are selected. The keypad calling function is added.	Selected System Keyboard

6. Click the [Finish] button.

- Click [View] → [Display Environment] and select the [Display Device] and [Display PLC No. when displaying device] checkboxes in the [Display Environment] window. Check that the device memory address is displayed at the lower left of each numerical data display part.

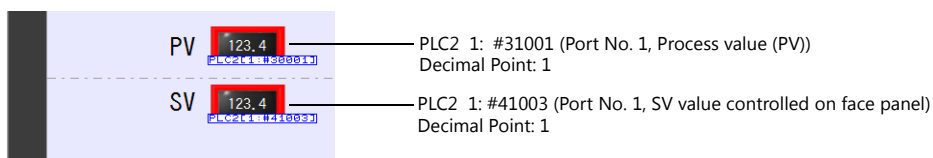

This completes the necessary settings.

PLC Device Memory (Transfer Destination)

- Click [Home] → [Data Display] → [Num. Display] and place a numerical data display part on the screen.
- Configure the following settings and click [OK].

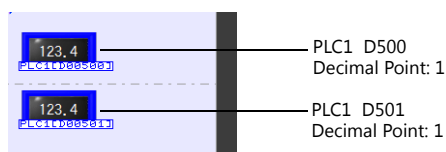

PXR (PLC2) Communication State Confirmation

The connection statuses of PLC1 to PLC8 are output to system device memory (\$P). Create a lamp for status display and numerical data display on the screen for checking the connection status.

Placing a Lamp

- Click [Home] → [Lamp] and place a lamp on the screen.
- Display the lamp's settings window and configure the following settings.

- Style

Item	Description	Setting Value
Lamp Device	Specify the device memory address for monitoring.	Internal \$P2: 10-01 (Port No. 1)

- Char. Prop.

Item	Description	Setting Value
Text	Set the text to be displayed on the lamp.	OFF: OK ON: NG

Link down information of PLC2 is stored in system memory at \$P2: 10 to \$P2: 225. 0: Normal, 1: Communication link down

Device Memory	Description
\$P2: 10-00	Link information for port No. 000
\$P2: \$P10-01	Link information for port No. 001
:	:
\$P2: \$P25-14	Link information for port No. 254
\$P2: \$P25-15	Link information for port No. 255



This completes the necessary settings.

Placing a Numerical Data Display Part

1. Click [Home] → [Data Display] → [Num. Display] and place a numerical data display part on the screen.
2. Display the numerical data display's settings window and configure the following settings.

- Contents

Item	Description	Setting Value
Device to Display	Specify the device memory address for monitoring.	Internal \$P2: 101-01
Display Format	Set the display format.	HEX



The error status of PLC2 is stored in system memory at \$P2: 100 to \$P2: 335.

0000H: Normal
 FFFFH: Timeout
 8001H: Check code error
 8002H: Data error
 800BH: Error code received from PLC2

Device Memory	Description
\$P2: 100	PLC2, Port No. 000 error status
\$P2: 101	PLC2, Port No. 001 error status
:	:
\$P2: 354	PLC2, Port No. 254 error status
\$P2: 355	PLC2, Port No. 255 error status

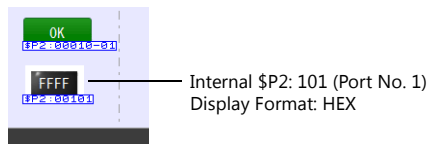

This completes the necessary settings.

Placing a Dotted Line, Text, and Switch for Returning to the Menu Screen

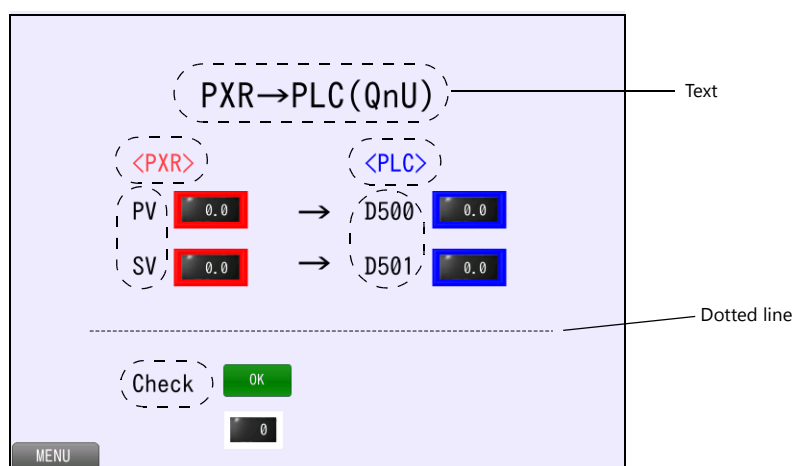

Dotted Line

1. Click [Home] → [Shape] → [Line] → [Straight Line]. The mouse cursor changes to a crosshair.
2. Drag horizontally while holding down the [Shift] key on the PC. A straight line is drawn.
3. Right-click or left-click at any position on the screen to return the mouse cursor to a pointer.
4. Display the item view window of the straight line and select a dotted line for [Line Type].

This completes the procedure for creating a dotted line.

Text

Create each text part of the screen.

1. Click [Home] → [Text] → [Text]. The mouse cursor changes to a crosshair.
2. Click on the screen. A text frame is displayed.
3. Enter text.
4. Click a location on the screen other than the text.
5. Click the text to display its item view window. Adjust the text color and size.

Switch

Create a switch for returning to the menu screen.

1. Click [Home] → [Switch] and place a switch on the screen.
2. Display the switch's settings window and set [Function] to "Screen Change-over" and [Switch to No] to "0".

This completes the screen creation process.

The next section covers screen operation after transferring the screen program to the V9 series unit.

9.5 Checking Unit Operation

9.5.1 List of Used Device Memory Addresses

Device Memory	Description	Remarks
PLC2 1: #31001 PLC2 1: #41003	Numerical data display	PLC2 1: #41003 only Keypad display enabled
D500 to D501	Numerical data display	

9.5.2 PXR (PLC2) Communication State Confirmation

Monitor and check the PXR communication status with the lamp and numerical data display.

- Normal

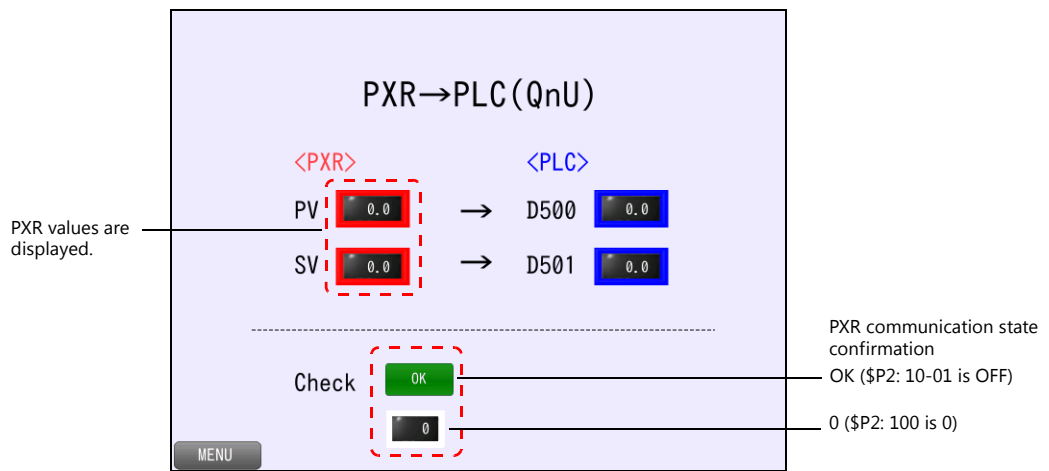

- Communication error

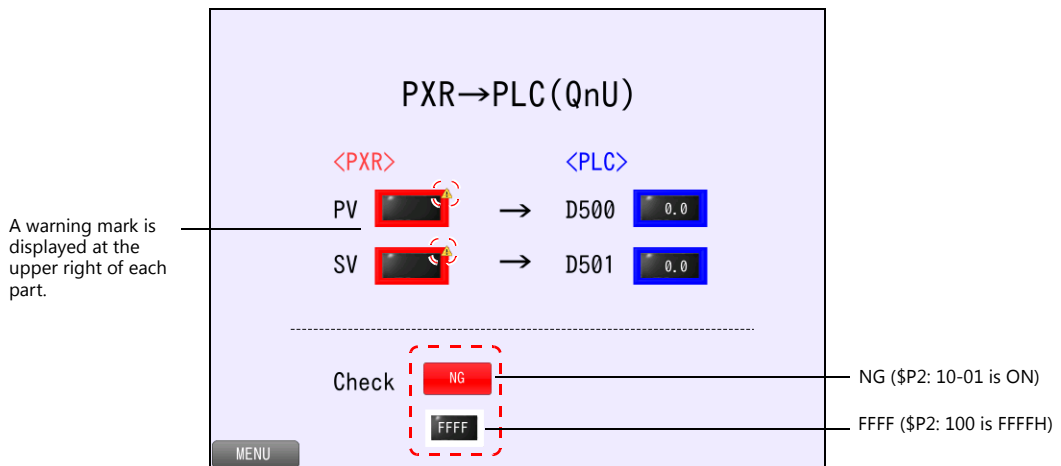

9.5.3 Unit Operation

1. Press the [SV] numerical data display of the PXR.

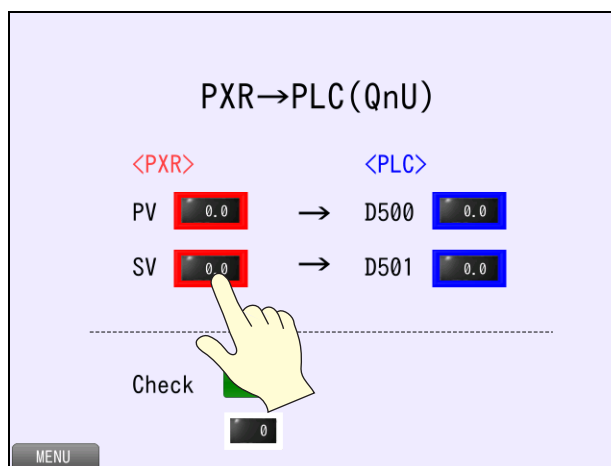

2. The system keyboard is displayed. Enter "23.5" and press the [Enter] key.

23.5 is written to SV of the PXR.

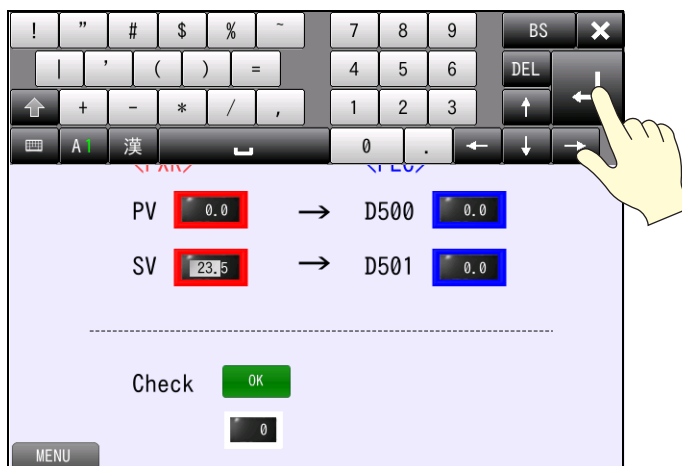

After 5 seconds, 23.5 is transferred to D501.

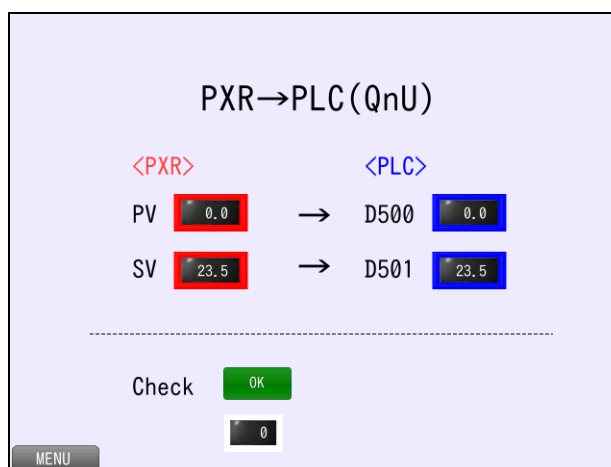

MEMO

MONITOUCH



10 Convenient Functions

10.1 Zoom in

10.1.1 Overview

The screen can be double-tapped to enlarge it. After enlarging the screen, the display can be scrolled to show off-screen content. A navigation display (a miniaturized display of the entire screen) is shown during scrolling to indicate the current display position.

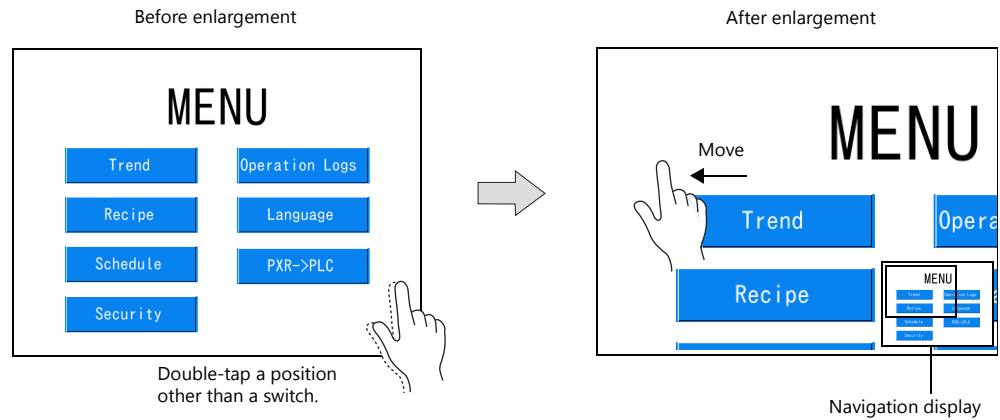

10.1.2 Screen Example

This example uses the menu screen (screen number 0).
Double-tap on the screen to zoom in.

10.1.3 Enlarged Display Settings

Configure the settings for enlarging the display.

1. Display screen No. 0. Click [Screen Setting] → [Screen Setting].

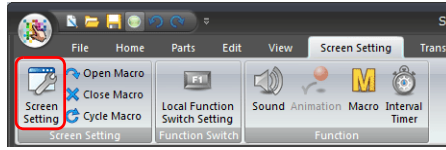

2. Display the [Scroll] tab. Configure the following settings.

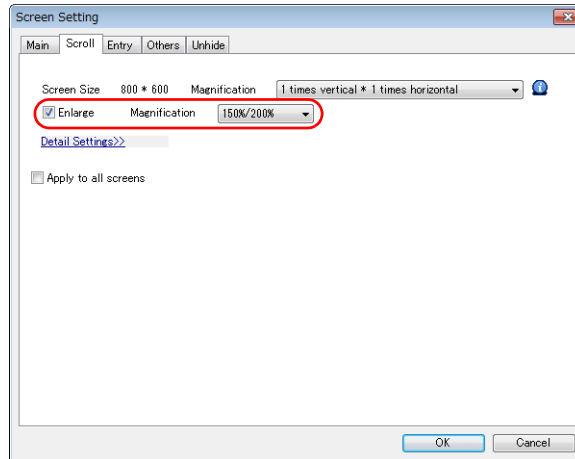

Item	Description	Setting Value
Enlarge	Double-tap on the screen to zoom in. The current magnification is output to \$s1641.	Selected
Magnification	Set the magnification. 150%, 150%/200%	150%/200%

This completes the necessary settings.
The screen program can be transferred to the V9 series unit.

10.1.4 Checking Unit Operation

Each time the screen is double-tapped, the display changes through the magnifications of 100% → 150% → 200% → 100% (actual size).

10.2 Enlarging the Screen Size

10.2.1 Overview

Screen sizes larger than the display size (resolution) of the V9 series unit can be registered. When a display is partially off-screen, the display can be scrolled to display the off-screen content. A navigation display is shown during movement when scrolling.

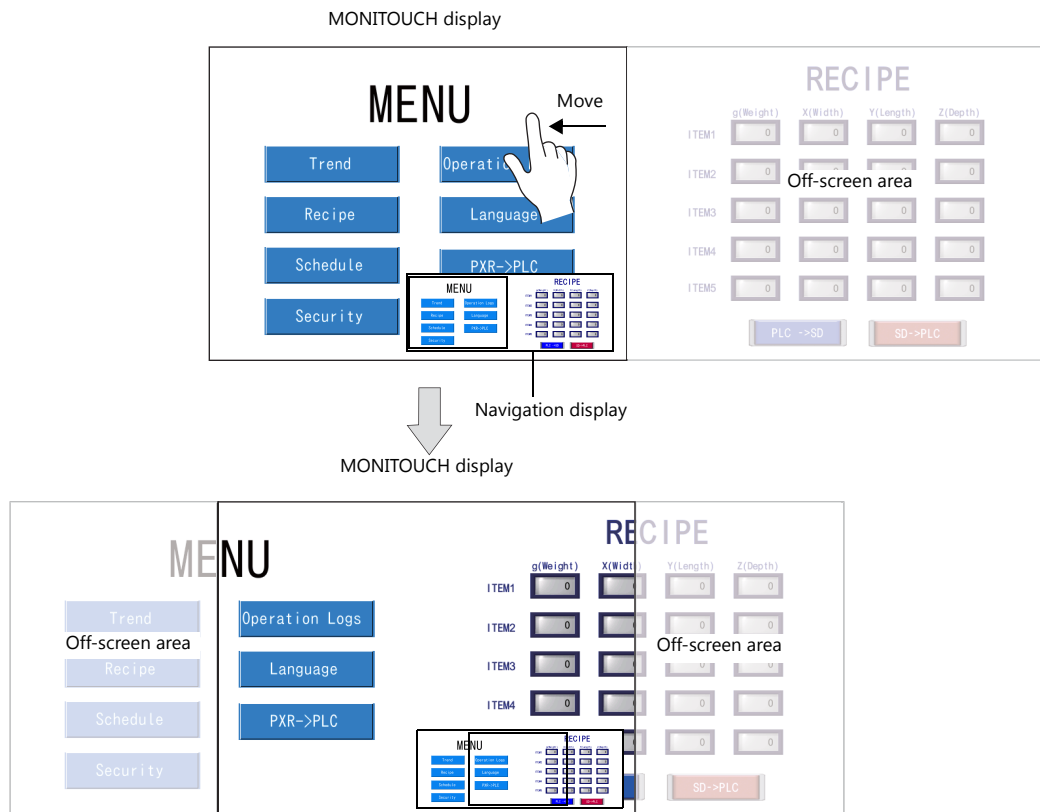

Settable Locations

Screens and overlaps

10.2.2 Screen Example

This example uses the menu screen (screen number 0).
Create a screen enlarged two times horizontally.

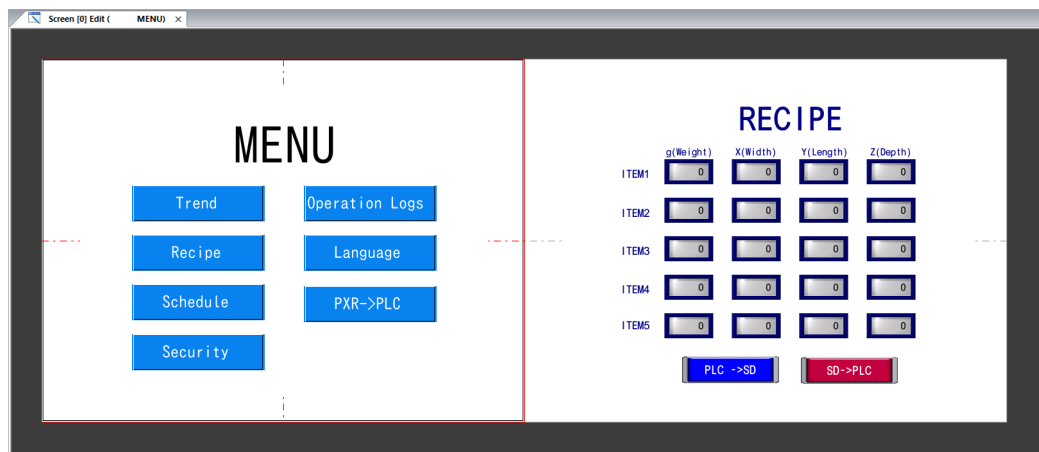

10.2.3 Screen Creation

1. Display screen No. 0. Click [Screen Setting] → [Screen Setting].

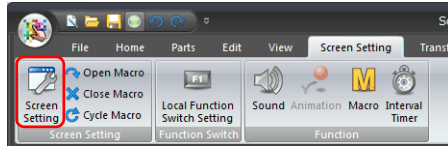

2. Display the [Scroll] tab. Configure the following settings.

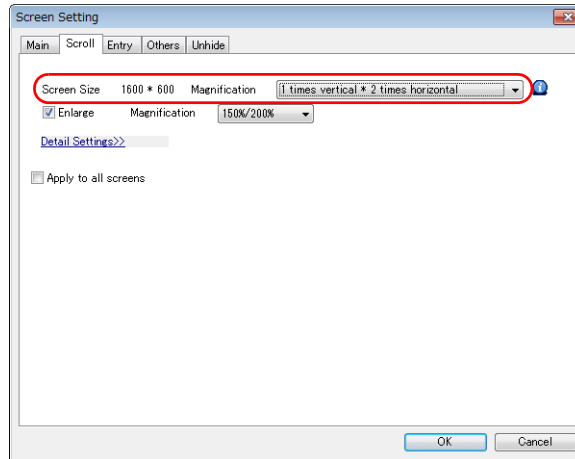

Item	Description	Setting Value
Screen size	Set the screen size.	1 times vertical × 2 times horizontal

3. Click [OK]. The screen size is extended two fold in the horizontal direction.

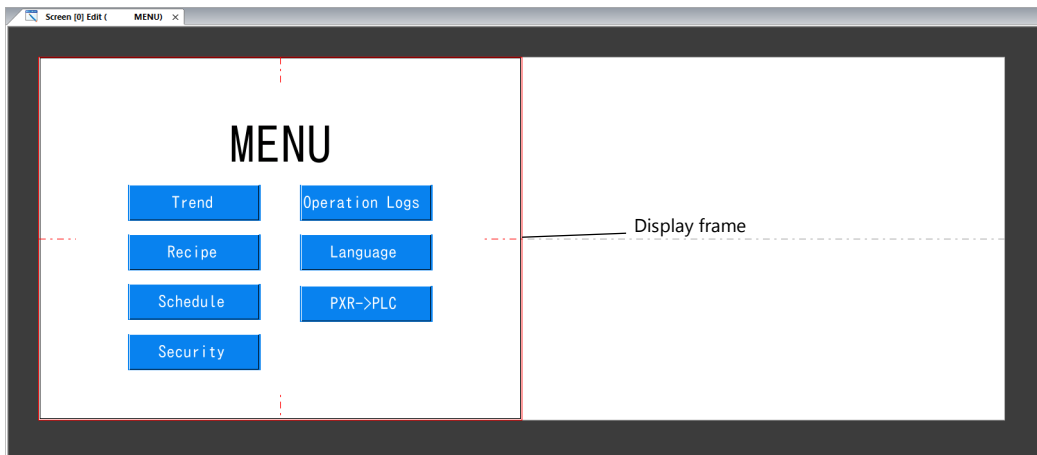

When editing the screen, the color of the display frame can be changed via [View] → [Grid Setting] → [Initial Frame Display].

- Copy and paste the recipe screen (screen number 2) on the right half of the screen.

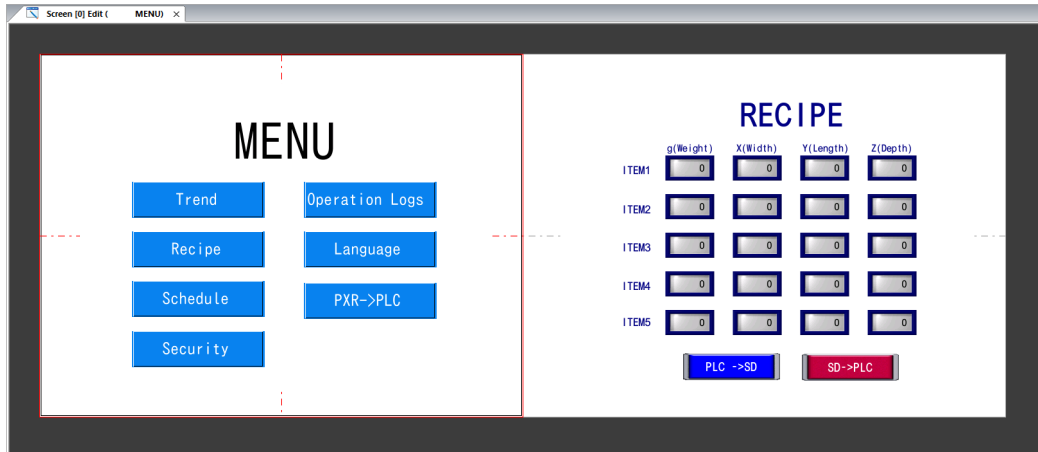

This completes the necessary settings.
The screen program can be transferred to the V9 series unit.

10.2.4 Checking Unit Operation

Scroll the screen horizontally to display the added recipe screen.

10.3 VNC Server

10.3.1 Overview

Connecting the V9 series unit to a PC or tablet over a network connection allows remote monitoring and operation of the screen on the V9 series unit.

- PC connection

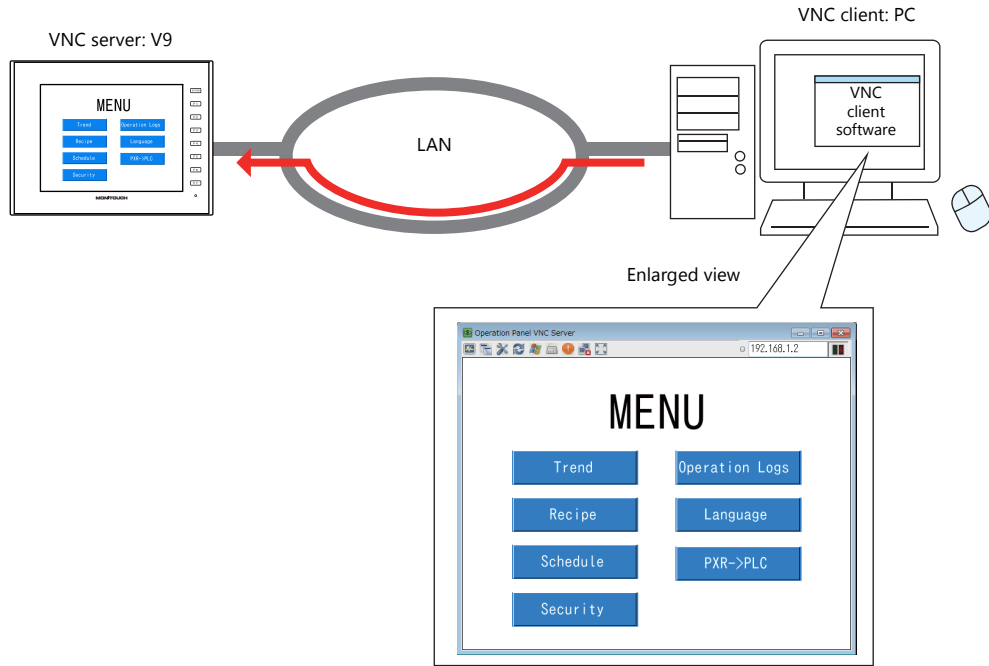

- Tablet connection

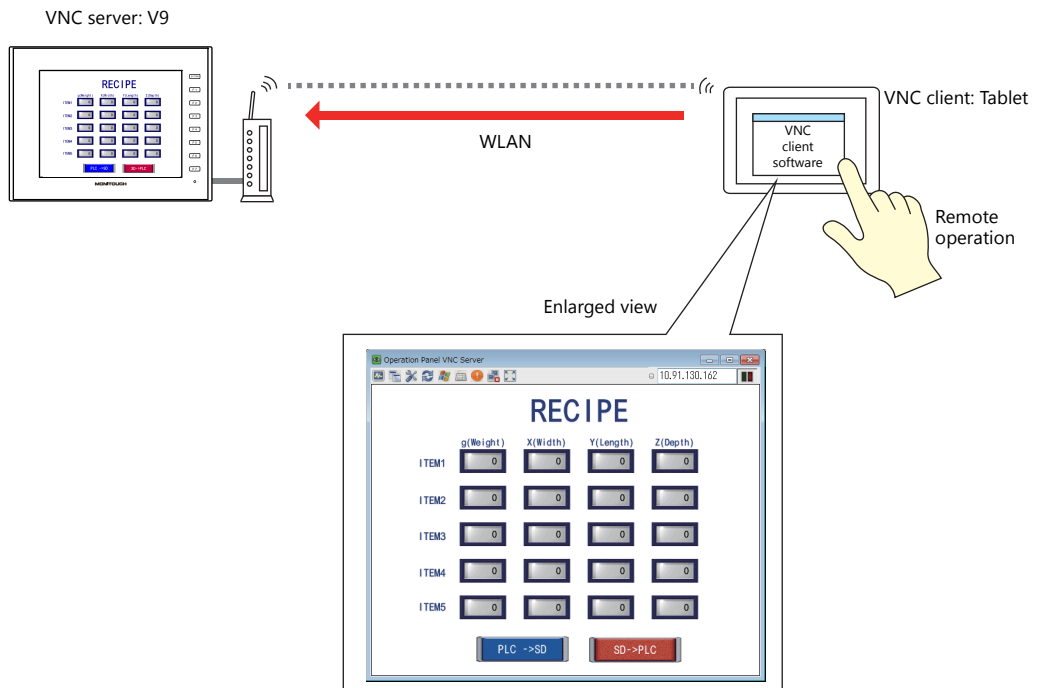

VNC
VNC stands for Virtual Network Computing. It is software for remotely operating the screen of other PCs connected to the network.

10.3.2 Operation Example

Connect the PC and V9 series unit via Ethernet and remotely operate the screen of the V9 series unit.

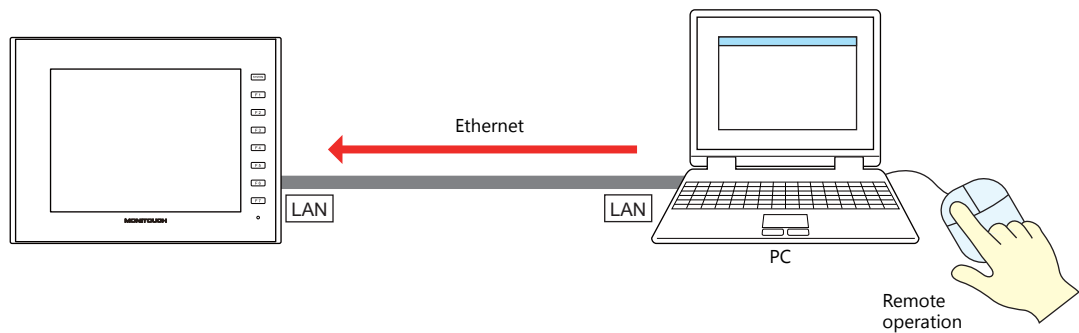

10.3.3 V9 Local Screen Settings

Switch to Local mode on the V9 series unit and configure the required settings for VNC connection. (No settings are required in the screen program.)

Switch to Local mode according to the following procedure.

Press the [SYSTEM] switch to display the system menu and then press [Local].

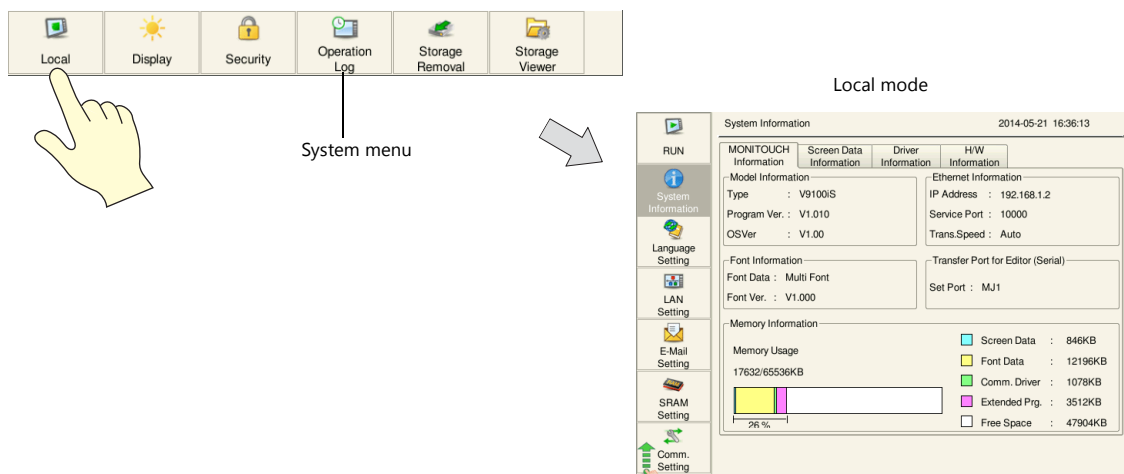

V9 IP Address Settings

Set the IP address of the V9 series unit.

1. Press the [LAN Setting] switch on the left side of the screen in Local mode to display the [LAN Setting] screen.

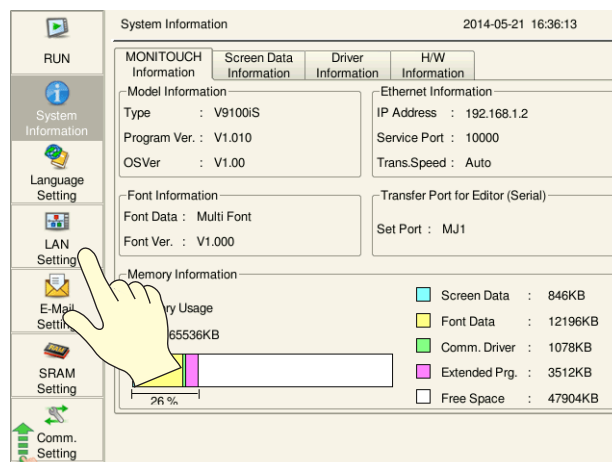

2. Tap each item to change its setting, such as IP address.

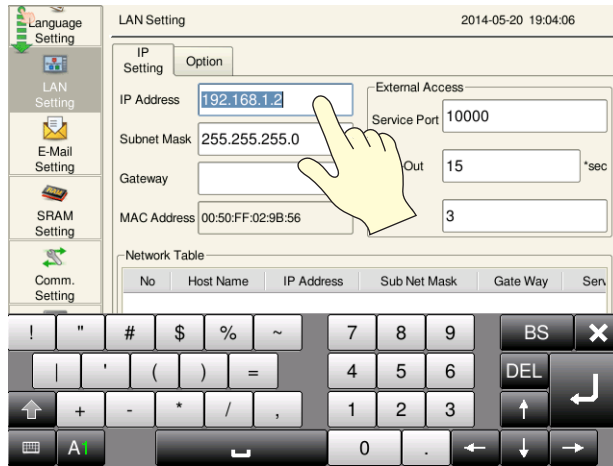

3. Press the [Apply] switch at the bottom right of the screen to accept the settings. When the changes are accepted, the [Apply] switch is disabled.

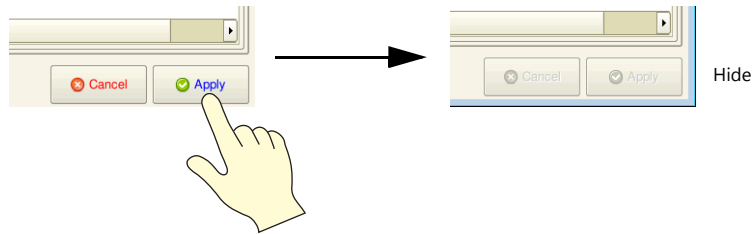

4. Press [System Information] on the left of the screen and check the IP address displayed under [Ethernet Information].

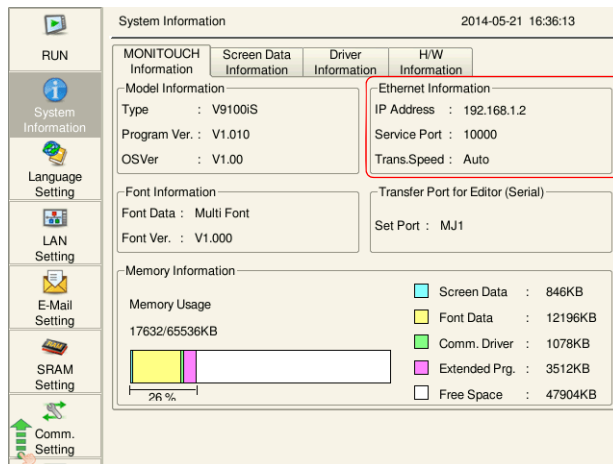

User Settings

Register the user name and password for accessing the VNC server on the [User Settings] screen in Local mode.

1. Press the [User Settings] switch on the left side of the screen to display the [User Settings] screen. A list of registered users is displayed.

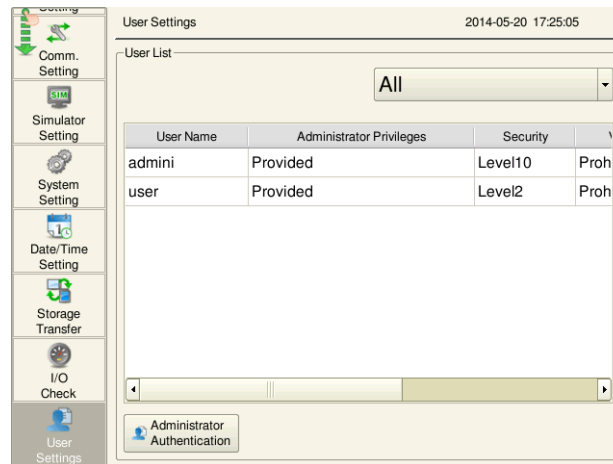

This user settings screen is the same for [Security], [VNC Server], and [FTP Server].

2. Press the [Administrator Authentication] switch.
3. Enter an administrator-level user name and password.
Use the user name registered in the chapter on security.

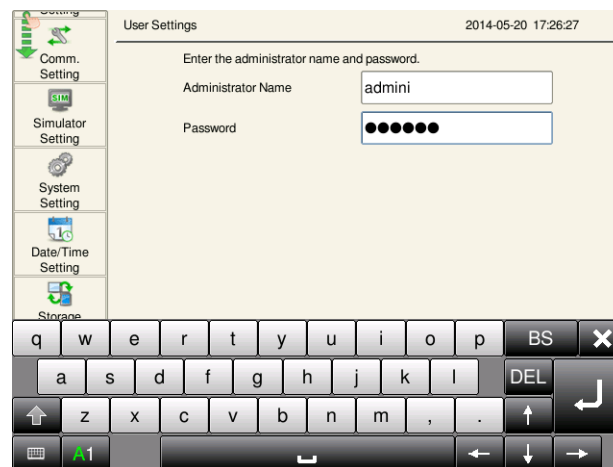

User name: admini
Password: admini

4. If the entries are correct, the user list in administrator mode is displayed.
Press the [Add] switch to display the add user screen. Configure the following settings.

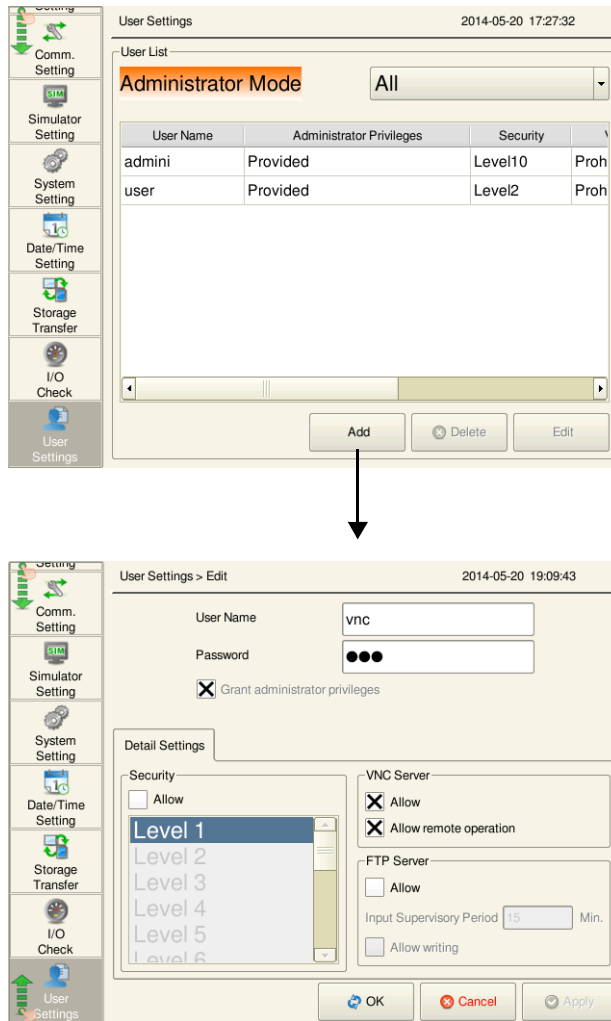

Item		Description	Setting Value
User Name		Register a user name. 16 one-byte alphanumeric characters	vnc
Password		Register a password. 16 one-byte alphanumeric characters	vnc
Grant administrator privileges		Select whether to grant administrator privileges to the user. With privileges: Users can be added, edited, and deleted in the list. Without privileges: Users cannot be added, edited, or deleted in the list.	Selected
VNC Server	Allow	Allow access from VNC clients.	Selected
	Allow remote operation	Allow operations from VNC clients. When remote operations are not allowed, only monitoring can be performed.	Selected

5. Press [OK] to complete registration. The display returns to the [User List (Administrator Mode)] screen.
6. Press [RUN] on the left of the screen and display the screen program.

This completes the necessary settings.

10.3.4 Checking Unit Operation

Before Checking Unit Operation

This chapter explains necessary settings using Ultra VNC as an example.
If the Ultra VNC software is not installed on the PC, install it.

Remote Monitoring and Operation

1. Start the Ultra VNC application on the PC via Windows Start menu → [UltraVNC] → [UltraVNC Viewer].
2. Enter the IP address of the V9 series unit into the [VNC Server] field and click [Connect].

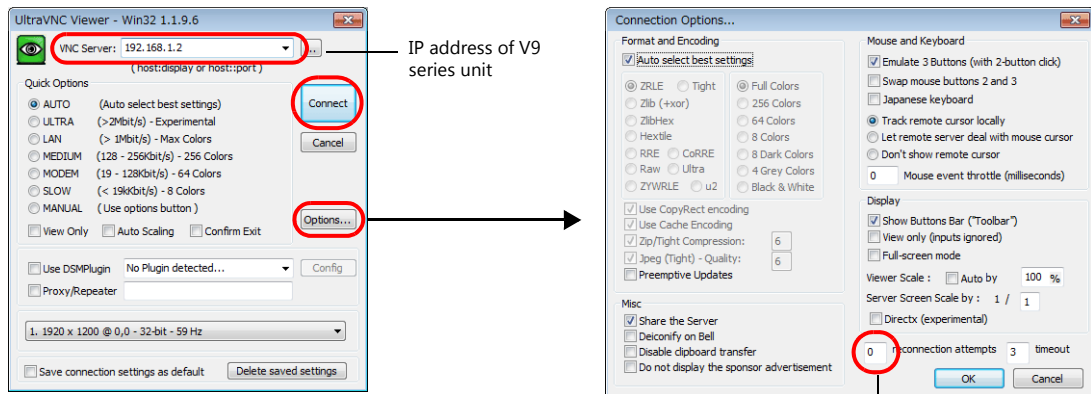

Set to 0 when using the forced disconnection function from the V9 series unit. For more information, refer to page 10-13.

3. The user authentication screen is displayed.
Enter the user name and password added in V9 Local mode and click [Connect].

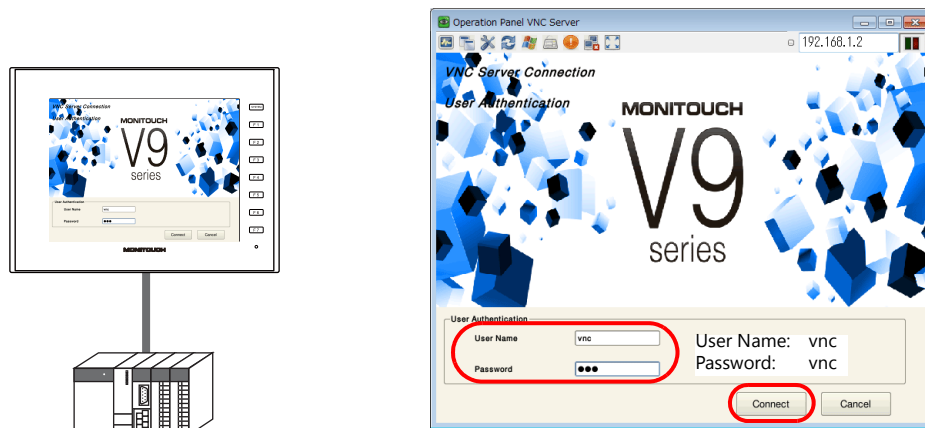

4. The V9 series unit screen is displayed in the VNC Viewer. Operating the VNC Viewer screen will change the display on the V9 series unit as well.

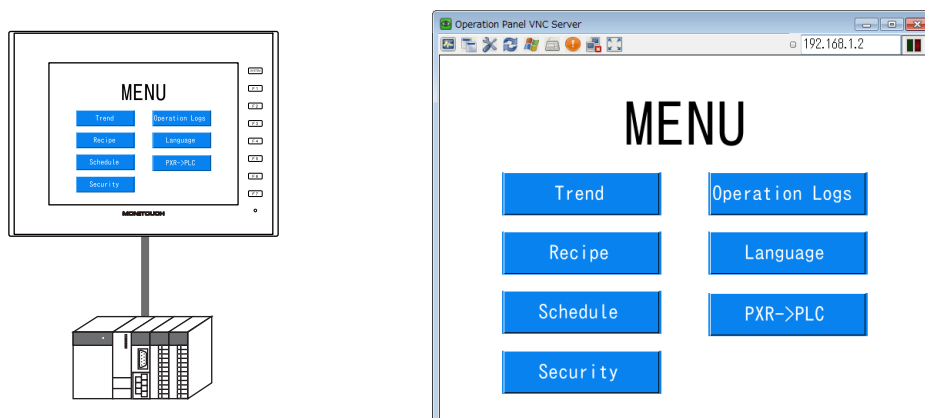

Displaying the System Menu and Status Bar

1. Press [F8] on the keyboard. This is the same operation as pressing the [SYSTEM] switch on the V9 series unit.

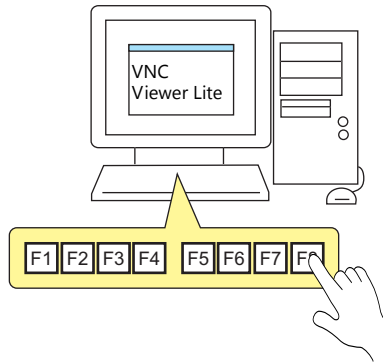

2. The system menu at the top of the screen and status bar at the bottom right of the screen are displayed.

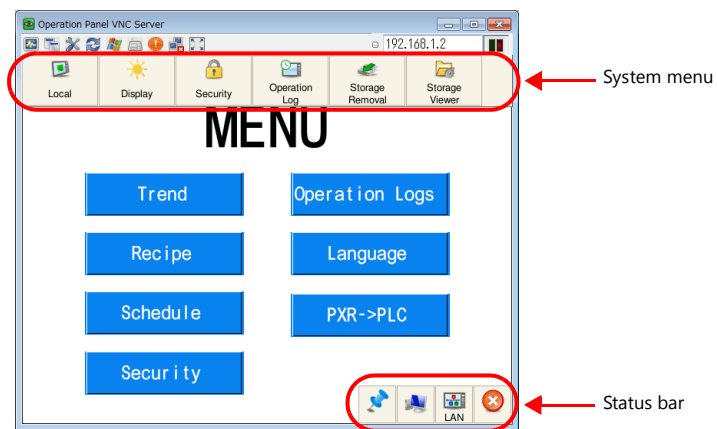

If remote operations are permitted from the VNC client, the following keyboard entry can be performed in addition to operations on the viewer screen.

- Entry screens: numerical and text entry
- Text boxes: numerical and text entry
- Function switch operation

VNC Client Keyboard	V9 Function Switch
F1	F1
F2	F2
F3	F3
F4	F4
F5	F5
F6	F6
F7	F7
F8	SYSTEM

Forcibly Disconnecting the VNC Client from the V9 Series Unit

1. If the VNC Viewer is running on the PC, exit the application.
2. Start the Ultra VNC application on the PC via Windows Start menu → [UltraVNC] → [UltraVNC Viewer].
3. Enter the IP address of the V9 series unit into the [VNC Server] field and click [Options].

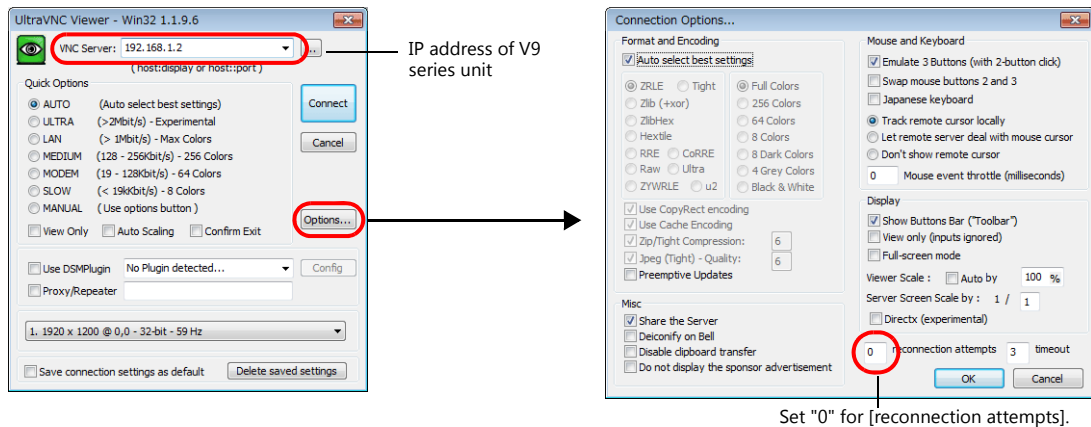

4. Click [Connect] and display the V9 series unit screen in the VNC viewer as described in "Remote Monitoring and Operation" P 10-11.
5. Press the [SYSTEM] function switch on the V9 series unit and display the status bar at the bottom right of the screen.

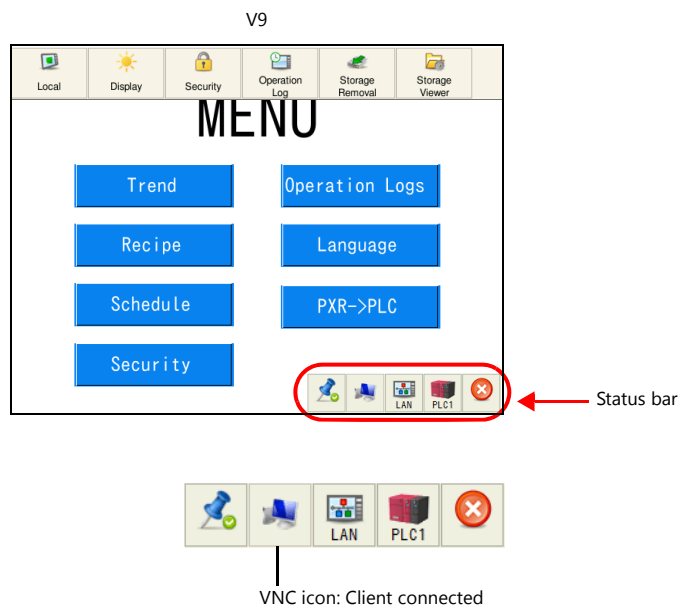

6. Press the VNC icon on the status bar.
The following dialog box is displayed. Click [OK].

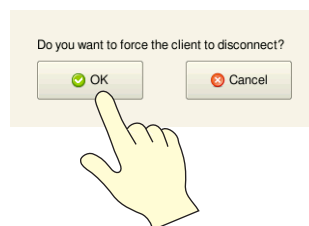

Communication is forcibly disconnected and the VNC viewer running on the PC exits.

*** When [reconnection attempts] is set to a value other than "0" in the settings of the VNC Viewer software, even if a forced disconnection is performed by the V9 series unit, the user authentication screen is displayed and cannot be dismissed.**

MEMO

MONITOUCH

